

# R&S® DVM50/100L/120 MPEG-2 Monitoring System Quick Start Guide



2085.1639.62 – 07

The Quick Start Guide describes the following R&S®DVM50/100L/120 models and options:

- R&S®DVM50 2085.1900.03
- R&S®DVM100L 2112.7050.02
- R&S®DVM120 2085.1700.03

This library makes uses of techniques from MPEG.

License notice:

THIS PRODUCT IS LICENSED UNDER THE AVC PATENT PORTFOLIO LICENSE FOR THE PERSONAL AND NON COMMERCIAL USE OF A CONSUMER TO (i) ENCODE VIDEO IN COMPLIANCE WITH THE AVC STANDARD ("AVC VIDEO") AND/OR (ii) DECODE AVC VIDEO THAT WAS ENCODED BY A CONSUMER ENGAGED IN A PERSONAL AND NON COMMERCIAL ACTIVITY AND/OR WAS OBTAINED FROM A VIDEO PROVIDER LICENSED TO PROVIDE AVC VIDEO. NO LICENSE IS GRANTED OR SHALL BE IMPLIED FOR ANY OTHER USE. ADDITIONAL INFORMATION MAY BE OBTAINED FROM MPEG LA, L.L.C.

SEE [HTTP://WWW.MPEGLA.COM](http://www.mpegla.com)

This library makes uses of techniques from Dolby.

Manufactured under license from Dolby Laboratories.

U.S. Patent Nos. 4,631,603; 4,819,098; 4,907,093; 5,315,448; 6,381,747; and 6,516,132.

Used for the Video and Audio Hardware Decoding option (R&S DVM-B30).

The firmware of the instrument makes use of several valuable open source software packages. For information see the release notes, included in the firmware package.

Rohde&Schwarz would like to thank the open source community for their valuable contribution to embedded computing.

© 2006 - 2012 Rohde & Schwarz GmbH & Co. KG

Muehldorfstr. 15, 81671 Munich, Germany

Phone: +49 89 41 29 - 0

Fax: +49 89 41 29 12 164

E-mail: [info@rohde-schwarz.com](mailto:info@rohde-schwarz.com)

Internet: <http://www.rohde-schwarz.com>

Printed in Germany – Subject to change – Data without tolerance limits is not binding.

R&S® is a registered trademark of Rohde & Schwarz GmbH & Co. KG.

Trade names are trademarks of the owners.

The following abbreviations are used throughout this manual:

R&S®DVM50/100L/120 is abbreviated as R&S DVM50/100L/120.

# Basic Safety Instructions

## **Always read through and comply with the following safety instructions!**

All plants and locations of the Rohde & Schwarz group of companies make every effort to keep the safety standards of our products up to date and to offer our customers the highest possible degree of safety. Our products and the auxiliary equipment they require are designed, built and tested in accordance with the safety standards that apply in each case. Compliance with these standards is continuously monitored by our quality assurance system. The product described here has been designed, built and tested in accordance with the attached EC Certificate of Conformity and has left the manufacturer's plant in a condition fully complying with safety standards. To maintain this condition and to ensure safe operation, you must observe all instructions and warnings provided in this manual. If you have any questions regarding these safety instructions, the Rohde & Schwarz group of companies will be happy to answer them.

Furthermore, it is your responsibility to use the product in an appropriate manner. This product is designed for use solely in industrial and laboratory environments or, if expressly permitted, also in the field and must not be used in any way that may cause personal injury or property damage. You are responsible if the product is used for any purpose other than its designated purpose or in disregard of the manufacturer's instructions. The manufacturer shall assume no responsibility for such use of the product.













The product is used for its designated purpose if it is used in accordance with its product documentation and within its performance limits (see data sheet, documentation, the following safety instructions). Using the product requires technical skills and, in some cases, a basic knowledge of English. It is therefore essential that only skilled and specialized staff or thoroughly trained personnel with the required skills be allowed to use the product. If personal safety gear is required for using Rohde & Schwarz products, this will be indicated at the appropriate place in the product documentation. Keep the basic safety instructions and the product documentation in a safe place and pass them on to the subsequent users.

Observing the safety instructions will help prevent personal injury or damage of any kind caused by dangerous situations. Therefore, carefully read through and adhere to the following safety instructions before and when using the product. It is also absolutely essential to observe the additional safety instructions on personal safety, for example, that appear in relevant parts of the product documentation. In these safety instructions, the word "product" refers to all merchandise sold and distributed by the Rohde & Schwarz group of companies, including instruments,

## Basic Safety Instructions

systems and all accessories. For product-specific information, see the data sheet and the product documentation.

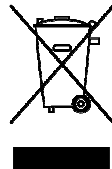



### Symbols and safety labels

Symbol	Meaning	Symbol	Meaning
	Notice, general danger location Observe product documentation	○	ON/OFF supply voltage
	Caution when handling heavy equipment	⏻	Standby indication
	Danger of electric shock	— — —	Direct current (DC)
	Warning! Hot surface	~	Alternating current (AC)
	Protective conductor terminal	⎓	Direct/alternating current (DC/AC)
	Ground		Device fully protected by double (reinforced) insulation
	Ground terminal		EU labeling for batteries and accumulators For additional information, see section "Waste disposal/Environmental protection", item 1.
	Be careful when handling electrostatic sensitive devices		EU labeling for separate collection of electrical and electronic devices For additional information, see section "Waste disposal/Environmental protection", item 2.
	Warning! Laser radiation For additional information, see section "Operation", item 7.		

## Basic Safety Instructions

### Signal words and their meaning

The following signal words are used in the product documentation in order to warn the reader about risks and dangers.

	Indicates an imminently hazardous situation which, if not avoided, will result in death or serious injury.
	Indicates a potentially hazardous situation which, if not avoided, could result in death or serious injury.
	Indicates a potentially hazardous situation which, if not avoided, could result in minor or moderate injury.
	Indicates the possibility of incorrect operation which can result in damage to the product. In the product documentation, the word ATTENTION is used synonymously.

These signal words are in accordance with the standard definition for civil applications in the European Economic Area. Definitions that deviate from the standard definition may also exist in other economic areas or military applications. It is therefore essential to make sure that the signal words described here are always used only in connection with the related product documentation and the related product. The use of signal words in connection with unrelated products or documentation can result in misinterpretation and in personal injury or material damage.

### Operating states and operating positions

*The product may be operated only under the operating conditions and in the positions specified by the manufacturer, without the product's ventilation being obstructed. If the manufacturer's specifications are not observed, this can result in electric shock, fire and/or serious personal injury or death. Applicable local or national safety regulations and rules for the prevention of accidents must be observed in all work performed.*

1. Unless otherwise specified, the following requirements apply to Rohde & Schwarz products:  
predefined operating position is always with the housing floor facing down, IP protection 2X, use only indoors, max. operating altitude 2000 m above sea level, max. transport altitude 4500 m above sea level. A tolerance of  $\pm 10\%$  shall apply to the nominal voltage and  $\pm 5\%$  to the nominal frequency, overvoltage category 2, pollution severity 2.

## Basic Safety Instructions

2. Do not place the product on surfaces, vehicles, cabinets or tables that for reasons of weight or stability are unsuitable for this purpose. Always follow the manufacturer's installation instructions when installing the product and fastening it to objects or structures (e.g. walls and shelves). An installation that is not carried out as described in the product documentation could result in personal injury or even death.
3. Do not place the product on heat-generating devices such as radiators or fan heaters. The ambient temperature must not exceed the maximum temperature specified in the product documentation or in the data sheet. Product overheating can cause electric shock, fire and/or serious personal injury or even death.

### Electrical safety

*If the information on electrical safety is not observed either at all or to the extent necessary, electric shock, fire and/or serious personal injury or death may occur.*

1. Prior to switching on the product, always ensure that the nominal voltage setting on the product matches the nominal voltage of the AC supply network. If a different voltage is to be set, the power fuse of the product may have to be changed accordingly.
2. In the case of products of safety class I with movable power cord and connector, operation is permitted only on sockets with a protective conductor contact and protective conductor.
3. Intentionally breaking the protective conductor either in the feed line or in the product itself is not permitted. Doing so can result in the danger of an electric shock from the product. If extension cords or connector strips are implemented, they must be checked on a regular basis to ensure that they are safe to use.
4. If there is no power switch for disconnecting the product from the AC supply network, or if the power switch is not suitable for this purpose, use the plug of the connecting cable to disconnect the product from the AC supply network. In such cases, always ensure that the power plug is easily reachable and accessible at all times. For example, if the power plug is the disconnecting device, the length of the connecting cable must not exceed 3 m. Functional or electronic switches are not suitable for providing disconnection from the AC supply network. If products without power switches are integrated into racks or systems, the disconnecting device must be provided at the system level.

## Basic Safety Instructions

5. Never use the product if the power cable is damaged. Check the power cables on a regular basis to ensure that they are in proper operating condition. By taking appropriate safety measures and carefully laying the power cable, ensure that the cable cannot be damaged and that no one can be hurt by, for example, tripping over the cable or suffering an electric shock.
6. The product may be operated only from TN/TT supply networks fuse-protected with max. 16 A (higher fuse only after consulting with the Rohde & Schwarz group of companies).
7. Do not insert the plug into sockets that are dusty or dirty. Insert the plug firmly and all the way into the socket provided for this purpose. Otherwise, sparks that result in fire and/or injuries may occur.
8. Do not overload any sockets, extension cords or connector strips; doing so can cause fire or electric shocks.
9. For measurements in circuits with voltages  $V_{\text{rms}} > 30 \text{ V}$ , suitable measures (e.g. appropriate measuring equipment, fuse protection, current limiting, electrical separation, insulation) should be taken to avoid any hazards.
10. Ensure that the connections with information technology equipment, e.g. PCs or other industrial computers, comply with the IEC60950-1/EN60950-1 or IEC61010-1/EN 61010-1 standards that apply in each case.
11. Unless expressly permitted, never remove the cover or any part of the housing while the product is in operation. Doing so will expose circuits and components and can lead to injuries, fire or damage to the product.
12. If a product is to be permanently installed, the connection between the protective conductor terminal on site and the product's protective conductor must be made first before any other connection is made. The product may be installed and connected only by a licensed electrician.
13. For permanently installed equipment without built-in fuses, circuit breakers or similar protective devices, the supply circuit must be fuse-protected in such a way that anyone who has access to the product, as well as the product itself, is adequately protected from injury or damage.
14. Use suitable overvoltage protection to ensure that no overvoltage (such as that caused by a bolt of lightning) can reach the product. Otherwise, the person operating the product will be exposed to the danger of an electric shock.
15. Any object that is not designed to be placed in the openings of the housing must not be used for this purpose. Doing so can cause short circuits inside the product and/or electric shocks, fire or injuries.

## Basic Safety Instructions

16. Unless specified otherwise, products are not liquid-proof (see also section "Operating states and operating positions", item 1). Therefore, the equipment must be protected against penetration by liquids. If the necessary precautions are not taken, the user may suffer electric shock or the product itself may be damaged, which can also lead to personal injury.
17. Never use the product under conditions in which condensation has formed or can form in or on the product, e.g. if the product has been moved from a cold to a warm environment. Penetration by water increases the risk of electric shock.
18. Prior to cleaning the product, disconnect it completely from the power supply (e.g. AC supply network or battery). Use a soft, non-linting cloth to clean the product. Never use chemical cleaning agents such as alcohol, acetone or diluents for cellulose lacquers.

## Operation

1. Operating the products requires special training and intense concentration. Make sure that persons who use the products are physically, mentally and emotionally fit enough to do so; otherwise, injuries or material damage may occur. It is the responsibility of the employer/operator to select suitable personnel for operating the products.
2. Before you move or transport the product, read and observe the section titled "Transport".
3. As with all industrially manufactured goods, the use of substances that induce an allergic reaction (allergens) such as nickel cannot be generally excluded. If you develop an allergic reaction (such as a skin rash, frequent sneezing, red eyes or respiratory difficulties) when using a Rohde & Schwarz product, consult a physician immediately to determine the cause and to prevent health problems or stress.
4. Before you start processing the product mechanically and/or thermally, or before you take it apart, be sure to read and pay special attention to the section titled "Waste disposal/Environmental protection", item 1.
5. Depending on the function, certain products such as RF radio equipment can produce an elevated level of electromagnetic radiation. Considering that unborn babies require increased protection, pregnant women must be protected by appropriate measures. Persons with pacemakers may also be exposed to risks from electromagnetic radiation. The employer/operator must evaluate workplaces where there is a special risk of exposure to radiation and, if necessary, take measures to avert the potential danger.



## Basic Safety Instructions

6. Should a fire occur, the product may release hazardous substances (gases, fluids, etc.) that can cause health problems. Therefore, suitable measures must be taken, e.g. protective masks and protective clothing must be worn.
7. Laser products are given warning labels that are standardized according to their laser class. Lasers can cause biological harm due to the properties of their radiation and due to their extremely concentrated electromagnetic power. If a laser product (e.g. a CD/DVD drive) is integrated into a Rohde & Schwarz product, absolutely no other settings or functions may be used as described in the product documentation. The objective is to prevent personal injury (e.g. due to laser beams).
8. EMC classes (in line with CISPR 11)  
Class A: Equipment suitable for use in all environments except residential environments and environments that are directly connected to a low-voltage supply network that supplies residential buildings.  
Class B: Equipment suitable for use in residential environments and environments that are directly connected to a low-voltage supply network that supplies residential buildings.

### Repair and service

1. The product may be opened only by authorized, specially trained personnel. Before any work is performed on the product or before the product is opened, it must be disconnected from the AC supply network. Otherwise, personnel will be exposed to the risk of an electric shock.
2. Adjustments, replacement of parts, maintenance and repair may be performed only by electrical experts authorized by Rohde & Schwarz. Only original parts may be used for replacing parts relevant to safety (e.g. power switches, power transformers, fuses). A safety test must always be performed after parts relevant to safety have been replaced (visual inspection, protective conductor test, insulation resistance measurement, leakage current measurement, functional test). This helps ensure the continued safety of the product.

### Batteries and rechargeable batteries/cells

*If the information regarding batteries and rechargeable batteries/cells is not observed either at all or to the extent necessary, product users may be exposed to the risk of explosions, fire and/or serious personal injury, and, in some cases, death. Batteries and rechargeable batteries with alkaline electrolytes (e.g. lithium cells) must be handled in accordance with the EN 62133 standard.*

## Basic Safety Instructions

1. Cells must not be taken apart or crushed.
2. Cells or batteries must not be exposed to heat or fire. Storage in direct sunlight must be avoided. Keep cells and batteries clean and dry. Clean soiled connectors using a dry, clean cloth.
3. Cells or batteries must not be short-circuited. Cells or batteries must not be stored in a box or in a drawer where they can short-circuit each other, or where they can be short-circuited by other conductive materials. Cells and batteries must not be removed from their original packaging until they are ready to be used.
4. Cells and batteries must not be exposed to any mechanical shocks that are stronger than permitted.
5. If a cell develops a leak, the fluid must not be allowed to come into contact with the skin or eyes. If contact occurs, wash the affected area with plenty of water and seek medical aid.
6. Improperly replacing or charging cells or batteries that contain alkaline electrolytes (e.g. lithium cells) can cause explosions. Replace cells or batteries only with the matching Rohde & Schwarz type (see parts list) in order to ensure the safety of the product.
7. Cells and batteries must be recycled and kept separate from residual waste. Rechargeable batteries and normal batteries that contain lead, mercury or cadmium are hazardous waste. Observe the national regulations regarding waste disposal and recycling.

## Transport

1. The product may be very heavy. Therefore, the product must be handled with care. In some cases, the user may require a suitable means of lifting or moving the product (e.g. with a lift-truck) to avoid back or other physical injuries.
2. Handles on the products are designed exclusively to enable personnel to transport the product. It is therefore not permissible to use handles to fasten the product to or on transport equipment such as cranes, fork lifts, wagons, etc. The user is responsible for securely fastening the products to or on the means of transport or lifting. Observe the safety regulations of the manufacturer of the means of transport or lifting. Noncompliance can result in personal injury or material damage.

## Basic Safety Instructions

3. If you use the product in a vehicle, it is the sole responsibility of the driver to drive the vehicle safely and properly. The manufacturer assumes no responsibility for accidents or collisions. Never use the product in a moving vehicle if doing so could distract the driver of the vehicle. Adequately secure the product in the vehicle to prevent injuries or other damage in the event of an accident.

### Waste disposal/Environmental protection

1. Specially marked equipment has a battery or accumulator that must not be disposed of with unsorted municipal waste, but must be collected separately. It may only be disposed of at a suitable collection point or via a Rohde & Schwarz customer service center.
2. Waste electrical and electronic equipment must not be disposed of with unsorted municipal waste, but must be collected separately. Rohde & Schwarz GmbH & Co. KG has developed a disposal concept and takes full responsibility for take-back obligations and disposal obligations for manufacturers within the EU. Contact your Rohde & Schwarz customer service center for environmentally responsible disposal of the product.
3. If products or their components are mechanically and/or thermally processed in a manner that goes beyond their intended use, hazardous substances (heavy-metal dust such as lead, beryllium, nickel) may be released. For this reason, the product may only be disassembled by specially trained personnel. Improper disassembly may be hazardous to your health. National waste disposal regulations must be observed.
4. If handling the product releases hazardous substances or fuels that must be disposed of in a special way, e.g. coolants or engine oils that must be replenished regularly, the safety instructions of the manufacturer of the hazardous substances or fuels and the applicable regional waste disposal regulations must be observed. Also observe the relevant safety instructions in the product documentation. The improper disposal of hazardous substances or fuels can cause health problems and lead to environmental damage.

For additional information about environmental protection, visit the Rohde & Schwarz website.

# Instrucciones de seguridad elementales

## **¡Es imprescindible leer y cumplir las siguientes instrucciones e informaciones de seguridad!**

El principio del grupo de empresas Rohde & Schwarz consiste en tener nuestros productos siempre al día con los estándares de seguridad y de ofrecer a nuestros clientes el máximo grado de seguridad. Nuestros productos y todos los equipos adicionales son siempre fabricados y examinados según las normas de seguridad vigentes. Nuestro sistema de garantía de calidad controla constantemente que sean cumplidas estas normas. El presente producto ha sido fabricado y examinado según el certificado de conformidad adjunto de la UE y ha salido de nuestra planta en estado impecable según los estándares técnicos de seguridad. Para poder preservar este estado y garantizar un funcionamiento libre de peligros, el usuario deberá atenerse a todas las indicaciones, informaciones de seguridad y notas de alerta. El grupo de empresas Rohde & Schwarz está siempre a su disposición en caso de que tengan preguntas referentes a estas informaciones de seguridad.









Además queda en la responsabilidad del usuario utilizar el producto en la forma debida. Este producto está destinado exclusivamente al uso en la industria y el laboratorio o, si ha sido expresamente autorizado, para aplicaciones de campo y de ninguna manera deberá ser utilizado de modo que alguna persona/cosa pueda sufrir daño. El uso del producto fuera de sus fines definidos o sin tener en cuenta las instrucciones del fabricante queda en la responsabilidad del usuario. El fabricante no se hace en ninguna forma responsable de consecuencias a causa del mal uso del producto.

Se parte del uso correcto del producto para los fines definidos si el producto es utilizado conforme a las indicaciones de la correspondiente documentación del producto y dentro del margen de rendimiento definido (ver hoja de datos, documentación, informaciones de seguridad que siguen). El uso del producto hace necesarios conocimientos técnicos y ciertos conocimientos del idioma inglés. Por eso se debe tener en cuenta que el producto solo pueda ser operado por personal especializado o personas instruidas en profundidad con las capacidades correspondientes. Si fuera necesaria indumentaria de seguridad para el uso de productos de Rohde & Schwarz, encontraría la información debida en la documentación del producto en el capítulo correspondiente. Guarde bien las informaciones de seguridad elementales, así como la documentación del producto, y entréguelas a usuarios posteriores.



## Instrucciones de seguridad elementales

Tener en cuenta las informaciones de seguridad sirve para evitar en lo posible lesiones o daños por peligros de toda clase. Por eso es imprescindible leer detalladamente y comprender por completo las siguientes informaciones de seguridad antes de usar el producto, y respetarlas durante el uso del producto. Deberán tenerse en cuenta todas las demás informaciones de seguridad, como p. ej. las referentes a la protección de personas, que encontrarán en el capítulo correspondiente de la documentación del producto y que también son de obligado cumplimiento. En las presentes informaciones de seguridad se recogen todos los objetos que distribuye el grupo de empresas Rohde & Schwarz bajo la denominación de "producto", entre ellos también aparatos, instalaciones así como toda clase de accesorios. Los datos específicos del producto figuran en la hoja de datos y en la documentación del producto.

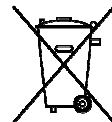
### Símbolos y definiciones de seguridad

Símbolo	Significado	Símbolo	Significado
	Aviso: punto de peligro general Observar la documentación del producto	○	Tensión de alimentación de PUESTA EN MARCHA / PARADA
	Atención en el manejo de dispositivos de peso elevado	⏻	Indicación de estado de espera (standby)
	Peligro de choque eléctrico	— — —	Corriente continua (DC)
	Advertencia: superficie caliente	~	Corriente alterna (AC)
	Conexión a conductor de protección	⎓	Corriente continua / Corriente alterna (DC/AC)
	Conexión a tierra		El aparato está protegido en su totalidad por un aislamiento doble (reforzado)
	Conexión a masa		Distintivo de la UE para baterías y acumuladores Más información en la sección "Eliminación/protección del medio ambiente", punto 1.

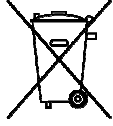
## Instrucciones de seguridad elementales

Símbolo	Significado	Símbolo	Significado
	Aviso: Cuidado en el manejo de dispositivos sensibles a la electrostática (ESD)	 	Distintivo de la UE para la eliminación por separado de dispositivos eléctricos y electrónicos  Más información en la sección "Eliminación/protección del medio ambiente", punto 2.
	Advertencia: rayo láser  Más información en la sección "Funcionamiento", punto 7.		

### Palabras de señal y su significado

En la documentación del producto se utilizan las siguientes palabras de señal con el fin de advertir contra riesgos y peligros.



PELIGRO identifica un peligro inminente con riesgo elevado que provocará muerte o lesiones graves si no se evita.



ADVERTENCIA identifica un posible peligro con riesgo medio de provocar muerte o lesiones (graves) si no se evita.



ATENCIÓN identifica un peligro con riesgo reducido de provocar lesiones leves o moderadas si no se evita.



AVISO indica la posibilidad de utilizar mal el producto y, como consecuencia, dañarlo.  
En la documentación del producto se emplea de forma sinónima el término CUIDADO.

Las palabras de señal corresponden a la definición habitual para aplicaciones civiles en el área económica europea. Pueden existir definiciones diferentes a esta definición en otras áreas económicas o en aplicaciones militares. Por eso se deberá tener en cuenta que las palabras de señal aquí descritas sean utilizadas siempre solamente en combinación con la correspondiente documentación del producto y solamente en combinación con el producto correspondiente. La utilización de las palabras de señal en combinación con productos o documentaciones que no les correspondan puede llevar a interpretaciones equivocadas y tener por consecuencia daños en personas u objetos.

## Instrucciones de seguridad elementales

### Estados operativos y posiciones de funcionamiento

*El producto solamente debe ser utilizado según lo indicado por el fabricante respecto a los estados operativos y posiciones de funcionamiento sin que se obstruya la ventilación. Si no se siguen las indicaciones del fabricante, pueden producirse choques eléctricos, incendios y/o lesiones graves con posible consecuencia de muerte. En todos los trabajos deberán ser tenidas en cuenta las normas nacionales y locales de seguridad del trabajo y de prevención de accidentes.*

1. Si no se convino de otra manera, es para los productos Rohde & Schwarz válido lo que sigue:  
como posición de funcionamiento se define por principio la posición con el suelo de la caja para abajo, modo de protección IP 2X, uso solamente en estancias interiores, utilización hasta 2000 m sobre el nivel del mar, transporte hasta 4500 m sobre el nivel del mar. Se aplicará una tolerancia de  $\pm 10\%$  sobre el voltaje nominal y de  $\pm 5\%$  sobre la frecuencia nominal. Categoría de sobrecarga eléctrica 2, índice de suciedad 2.
2. No sitúe el producto encima de superficies, vehículos, estantes o mesas, que por sus características de peso o de estabilidad no sean aptos para él. Siga siempre las instrucciones de instalación del fabricante cuando instale y asegure el producto en objetos o estructuras (p. ej. paredes y estantes). Si se realiza la instalación de modo distinto al indicado en la documentación del producto, se pueden causar lesiones o, en determinadas circunstancias, incluso la muerte.
3. No ponga el producto sobre aparatos que generen calor (p. ej. radiadores o calefactores). La temperatura ambiente no debe superar la temperatura máxima especificada en la documentación del producto o en la hoja de datos. En caso de sobrecalentamiento del producto, pueden producirse choques eléctricos, incendios y/o lesiones graves con posible consecuencia de muerte.

### Seguridad eléctrica

*Si no se siguen (o se siguen de modo insuficiente) las indicaciones del fabricante en cuanto a seguridad eléctrica, pueden producirse choques eléctricos, incendios y/o lesiones graves con posible consecuencia de muerte.*

1. Antes de la puesta en marcha del producto se deberá comprobar siempre que la tensión preseleccionada en el producto coincida con la de la red de alimentación eléctrica. Si es necesario modificar el ajuste de tensión, también se deberán cambiar en caso dado los fusibles correspondientes del producto.

## Instrucciones de seguridad elementales

2. Los productos de la clase de protección I con alimentación móvil y enchufe individual solamente podrán enchufarse a tomas de corriente con contacto de seguridad y con conductor de protección conectado.
3. Queda prohibida la interrupción intencionada del conductor de protección, tanto en la toma de corriente como en el mismo producto. La interrupción puede tener como consecuencia el riesgo de que el producto sea fuente de choques eléctricos. Si se utilizan cables alargadores o regletas de enchufe, deberá garantizarse la realización de un examen regular de los mismos en cuanto a su estado técnico de seguridad.
4. Si el producto no está equipado con un interruptor para desconectarlo de la red, o bien si el interruptor existente no resulta apropiado para la desconexión de la red, el enchufe del cable de conexión se deberá considerar como un dispositivo de desconexión.  
El dispositivo de desconexión se debe poder alcanzar fácilmente y debe estar siempre bien accesible. Si, p. ej., el enchufe de conexión a la red es el dispositivo de desconexión, la longitud del cable de conexión no debe superar 3 m).  
Los interruptores selectores o electrónicos no son aptos para el corte de la red eléctrica. Si se integran productos sin interruptor en bastidores o instalaciones, se deberá colocar el interruptor en el nivel de la instalación.
5. No utilice nunca el producto si está dañado el cable de conexión a red. Compruebe regularmente el correcto estado de los cables de conexión a red. Asegúrese, mediante las medidas de protección y de instalación adecuadas, de que el cable de conexión a red no pueda ser dañado o de que nadie pueda ser dañado por él, p. ej. al tropezar o por un choque eléctrico.
6. Solamente está permitido el funcionamiento en redes de alimentación TN/TT aseguradas con fusibles de 16 A como máximo (utilización de fusibles de mayor amperaje solo previa consulta con el grupo de empresas Rohde & Schwarz).
7. Nunca conecte el enchufe en tomas de corriente sucias o llenas de polvo. Introduzca el enchufe por completo y fuertemente en la toma de corriente. La no observación de estas medidas puede provocar chispas, fuego y/o lesiones.
8. No sobrecargue las tomas de corriente, los cables alargadores o las regletas de enchufe ya que esto podría causar fuego o choques eléctricos.
9. En las mediciones en circuitos de corriente con una tensión  $U_{\text{eff}} > 30 \text{ V}$  se deberán tomar las medidas apropiadas para impedir cualquier peligro (p. ej. medios de medición adecuados, seguros, limitación de tensión, corte protector, aislamiento etc.).



## Instrucciones de seguridad elementales

10. Para la conexión con dispositivos informáticos como un PC o un ordenador industrial, debe comprobarse que éstos cumplan los estándares IEC60950-1/EN60950-1 o IEC61010-1/EN 61010-1 válidos en cada caso.
11. A menos que esté permitido expresamente, no retire nunca la tapa ni componentes de la carcasa mientras el producto esté en servicio. Esto pone a descubierto los cables y componentes eléctricos y puede causar lesiones, fuego o daños en el producto.
12. Si un producto se instala en un lugar fijo, se deberá primero conectar el conductor de protección fijo con el conductor de protección del producto antes de hacer cualquier otra conexión. La instalación y la conexión deberán ser efectuadas por un electricista especializado.
13. En el caso de dispositivos fijos que no estén provistos de fusibles, interruptor automático ni otros mecanismos de seguridad similares, el circuito de alimentación debe estar protegido de modo que todas las personas que puedan acceder al producto, así como el producto mismo, estén a salvo de posibles daños.
14. Todo producto debe estar protegido contra sobretensión (debida p. ej. a una caída del rayo) mediante los correspondientes sistemas de protección. Si no, el personal que lo utilice quedará expuesto al peligro de choque eléctrico.
15. No debe introducirse en los orificios de la caja del aparato ningún objeto que no esté destinado a ello. Esto puede producir cortocircuitos en el producto y/o puede causar choques eléctricos, fuego o lesiones.
16. Salvo indicación contraria, los productos no están impermeabilizados (ver también el capítulo "Estados operativos y posiciones de funcionamiento", punto 1). Por eso es necesario tomar las medidas necesarias para evitar la entrada de líquidos. En caso contrario, existe peligro de choque eléctrico para el usuario o de daños en el producto, que también pueden redundar en peligro para las personas.
17. No utilice el producto en condiciones en las que pueda producirse o ya se hayan producido condensaciones sobre el producto o en el interior de éste, como p. ej. al desplazarlo de un lugar frío a otro caliente. La entrada de agua aumenta el riesgo de choque eléctrico.
18. Antes de la limpieza, desconecte por completo el producto de la alimentación de tensión (p. ej. red de alimentación o batería). Realice la limpieza de los aparatos con un paño suave, que no se deshilache. No utilice bajo ningún concepto productos de limpieza químicos como alcohol, acetona o diluyentes para lacas nitrocelulósicas.

## Instrucciones de seguridad elementales

### Funcionamiento

1. El uso del producto requiere instrucciones especiales y una alta concentración durante el manejo. Debe asegurarse que las personas que manejen el producto estén a la altura de los requerimientos necesarios en cuanto a aptitudes físicas, psíquicas y emocionales, ya que de otra manera no se pueden excluir lesiones o daños de objetos. El empresario u operador es responsable de seleccionar el personal usuario apto para el manejo del producto.
2. Antes de desplazar o transportar el producto, lea y tenga en cuenta el capítulo "Transporte".
3. Como con todo producto de fabricación industrial no puede quedar excluida en general la posibilidad de que se produzcan alergias provocadas por algunos materiales empleados —los llamados alérgenos (p. ej. el níquel)—. Si durante el manejo de productos Rohde & Schwarz se producen reacciones alérgicas, como p. ej. irritaciones cutáneas, estornudos continuos, enrojecimiento de la conjuntiva o dificultades respiratorias, debe avisarse inmediatamente a un médico para investigar las causas y evitar cualquier molestia o daño a la salud.
4. Antes de la manipulación mecánica y/o térmica o el desmontaje del producto, debe tenerse en cuenta imprescindiblemente el capítulo "Eliminación/protección del medio ambiente", punto 1.
5. Ciertos productos, como p. ej. las instalaciones de radiocomunicación RF, pueden a causa de su función natural, emitir una radiación electromagnética aumentada. Deben tomarse todas las medidas necesarias para la protección de las mujeres embarazadas. También las personas con marcapasos pueden correr peligro a causa de la radiación electromagnética. El empresario/operador tiene la obligación de evaluar y señalar las áreas de trabajo en las que exista un riesgo elevado de exposición a radiaciones.
6. Tenga en cuenta que en caso de incendio pueden desprenderse del producto sustancias tóxicas (gases, líquidos etc.) que pueden generar daños a la salud. Por eso, en caso de incendio deben usarse medidas adecuadas, como p. ej. máscaras antigás e indumentaria de protección.

## Instrucciones de seguridad elementales

7. Los productos con láser están provistos de indicaciones de advertencia normalizadas en función de la clase de láser del que se trate. Los rayos láser pueden provocar daños de tipo biológico a causa de las propiedades de su radiación y debido a su concentración extrema de potencia electromagnética. En caso de que un producto Rohde & Schwarz contenga un producto láser (p. ej. un lector de CD/DVD), no debe usarse ninguna otra configuración o función aparte de las descritas en la documentación del producto, a fin de evitar lesiones (p. ej. debidas a irradiación láser).
8. Clases CEM (según CISPR 11)  
Clase A: dispositivo apropiado para el uso en cualquier zona excepto en áreas residenciales y en aquellas zonas que se encuentran conectadas a una red de suministro de baja tensión que alimenta un edificio de viviendas.  
Clase B: dispositivo apropiado para el uso en áreas residenciales y en aquellas zonas que se encuentran conectadas a una red de suministro de baja tensión que alimenta un edificio de viviendas.

### Reparación y mantenimiento

1. El producto solamente debe ser abierto por personal especializado con autorización para ello. Antes de manipular el producto o abrirlo, es obligatorio desconectarlo de la tensión de alimentación, para evitar toda posibilidad de choque eléctrico.
2. El ajuste, el cambio de partes, el mantenimiento y la reparación deberán ser efectuadas solamente por electricistas autorizados por Rohde & Schwarz. Si se reponen partes con importancia para los aspectos de seguridad (p. ej. el enchufe, los transformadores o los fusibles), solamente podrán ser sustituidos por partes originales. Después de cada cambio de partes relevantes para la seguridad deberá realizarse un control de seguridad (control a primera vista, control del conductor de protección, medición de resistencia de aislamiento, medición de la corriente de fuga, control de funcionamiento). Con esto queda garantizada la seguridad del producto.

### Baterías y acumuladores o celdas

*Si no se siguen (o se siguen de modo insuficiente) las indicaciones en cuanto a las baterías y acumuladores o celdas, pueden producirse explosiones, incendios y/o lesiones graves con posible consecuencia de muerte. El manejo de baterías y acumuladores con electrolitos alcalinos (p. ej. celdas de litio) debe seguir el estándar EN 62133.*

## **Instrucciones de seguridad elementales**

1. No deben desmontarse, abrirse ni triturarse las celdas.
2. Las celdas o baterías no deben someterse a calor ni fuego. Debe evitarse el almacenamiento a la luz directa del sol. Las celdas y baterías deben mantenerse limpias y secas. Limpiar las conexiones sucias con un paño seco y limpio.
3. Las celdas o baterías no deben cortocircuitarse. Es peligroso almacenar las celdas o baterías en estuches o cajones en cuyo interior puedan cortocircuitarse por contacto recíproco o por contacto con otros materiales conductores. No deben extraerse las celdas o baterías de sus embalajes originales hasta el momento en que vayan a utilizarse.
4. Las celdas o baterías no deben someterse a impactos mecánicos fuertes indebidos.
5. En caso de falta de estanqueidad de una celda, el líquido vertido no debe entrar en contacto con la piel ni los ojos. Si se produce contacto, lavar con agua abundante la zona afectada y avisar a un médico.
6. En caso de cambio o recarga inadecuados, las celdas o baterías que contienen electrolitos alcalinos (p. ej. las celdas de litio) pueden explotar. Para garantizar la seguridad del producto, las celdas o baterías solo deben ser sustituidas por el tipo Rohde & Schwarz correspondiente (ver lista de recambios).
7. Las baterías y celdas deben reciclarse y no deben tirarse a la basura doméstica. Las baterías o acumuladores que contienen plomo, mercurio o cadmio deben tratarse como residuos especiales. Respete en esta relación las normas nacionales de eliminación y reciclaje.

### **Transporte**

1. El producto puede tener un peso elevado. Por eso es necesario desplazarlo o transportarlo con precaución y, si es necesario, usando un sistema de elevación adecuado (p. ej. una carretilla elevadora), a fin de evitar lesiones en la espalda u otros daños personales.
2. Las asas instaladas en los productos sirven solamente de ayuda para el transporte del producto por personas. Por eso no está permitido utilizar las asas para la sujeción en o sobre medios de transporte como p. ej. grúas, carretillas elevadoras de horquilla, carros etc. Es responsabilidad suya fijar los productos de manera segura a los medios de transporte o elevación. Para evitar daños personales o daños en el producto, siga las instrucciones de seguridad del fabricante del medio de transporte o elevación utilizado.

## **Instrucciones de seguridad elementales**

3. Si se utiliza el producto dentro de un vehículo, recae de manera exclusiva en el conductor la responsabilidad de conducir el vehículo de manera segura y adecuada. El fabricante no asumirá ninguna responsabilidad por accidentes o colisiones. No utilice nunca el producto dentro de un vehículo en movimiento si esto pudiera distraer al conductor. Asegure el producto dentro del vehículo debidamente para evitar, en caso de un accidente, lesiones u otra clase de daños.

### **Eliminación/protección del medio ambiente**

1. Los dispositivos marcados contienen una batería o un acumulador que no se debe desechar con los residuos domésticos sin clasificar, sino que debe ser recogido por separado. La eliminación se debe efectuar exclusivamente a través de un punto de recogida apropiado o del servicio de atención al cliente de Rohde & Schwarz.
2. Los dispositivos eléctricos usados no se deben desechar con los residuos domésticos sin clasificar, sino que deben ser recogidos por separado. Rohde & Schwarz GmbH & Co.KG ha elaborado un concepto de eliminación de residuos y asume plenamente los deberes de recogida y eliminación para los fabricantes dentro de la UE. Para desechar el producto de manera respetuosa con el medio ambiente, diríjase a su servicio de atención al cliente de Rohde & Schwarz.
3. Si se trabaja de manera mecánica y/o térmica cualquier producto o componente más allá del funcionamiento previsto, pueden liberarse sustancias peligrosas (polvos con contenido de metales pesados como p. ej. plomo, berilio o níquel). Por eso el producto solo debe ser desmontado por personal especializado con formación adecuada. Un desmontaje inadecuado puede ocasionar daños para la salud. Se deben tener en cuenta las directivas nacionales referentes a la eliminación de residuos.
4. En caso de que durante el trato del producto se formen sustancias peligrosas o combustibles que deban tratarse como residuos especiales (p. ej. refrigerantes o aceites de motor con intervalos de cambio definidos), deben tenerse en cuenta las indicaciones de seguridad del fabricante de dichas sustancias y las normas regionales de eliminación de residuos. Tenga en cuenta también en caso necesario las indicaciones de seguridad especiales contenidas en la documentación del producto. La eliminación incorrecta de sustancias peligrosas o combustibles puede causar daños a la salud o daños al medio ambiente.

Se puede encontrar más información sobre la protección del medio ambiente en la página web de Rohde & Schwarz.

## Safety Instructions for Instruments with Fold-Out Feet

**⚠ WARNING**

### Danger of injury

The feet may fold in if they are not folded out completely or if the instrument is shifted. The feet may break if they are overloaded.

Fold the feet completely in or completely out to ensure stability of the instrument and personal safety.

To avoid injuries, never shift the instrument when its feet are folded out.

The overall load (the instrument's own weight plus that of the instruments stacked on top of it) on the folded-out feet must not exceed 500 N.

Place the instrument on a stable surface. Secure the instruments stacked on top of it against slipping (e.g. by locking their feet on the top front frame).

When the instrument is standing on its folded-out feet, do not work under the instrument and do not put anything under it, otherwise injuries or material damage could occur.

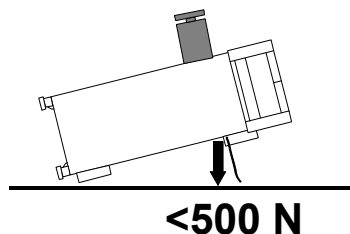

The instrument can be used in each of the positions shown here.

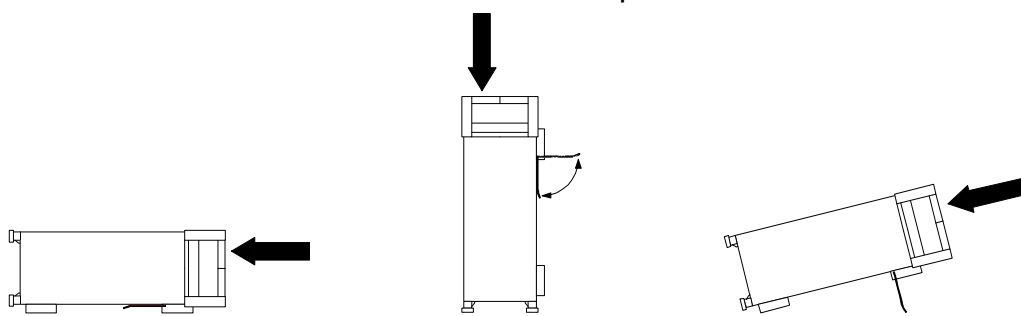

## Informaciones de seguridad para aparatos con telepiés

### **⚠ ADVERTENCIA**

#### **Peligro de heridas**

Los telepiés pueden doblarse hacia adentro si no han sido desdoblados por completo o si el aparato es movido. Los telepiés pueden romperse si son sobrecargados.

Doblar los telepiés por completo hacia afuera o hacia adentro. De esta manera se puede asegurar la estabilidad del aparato y a la vez la seguridad de las personas.

No mover nunca el aparato con los telepiés desdoblados, para evitar heridas.

El peso total equilibrado (peso propio más el de los aparatos posicionados sobre este) ejercido sobre los telepiés no deberá exceder a los 500 N.

Posicionar el aparato sobre una superficie estable. Los aparatos puestos encima de éste deben estar asegurados para que no resbalen (por ejemplo fijando los pies del aparato en el listón del marco de delante arriba).

Por favor no manipulen debajo del aparato y no pongan nada debajo de este cuando esté posicionado sobre los telepiés desdoblados, ya que si no pueden originarse heridas o daños en objetos.

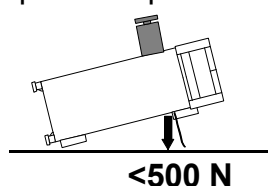

El aparato puede ser puesto en funcionamiento en cualquiera de las posiciones aquí descritas.

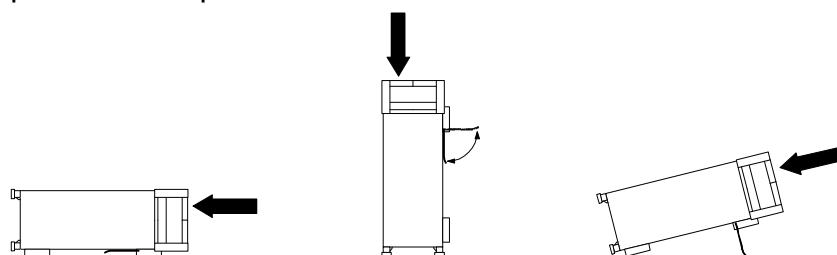

## Safety Instructions for Stacking Instruments

**⚠ WARNING**

### Danger of injury

Instruments may slip if they are stacked on top of each other.

Place the instrument on a stable, even surface. Stack the instruments according to their size, with the largest instrument on the bottom. Do not stack more than three instruments directly on top of each other. Instruments may only be stacked if their feet and housing allow horizontal stacking. If these conditions are not met, the instruments must be installed in a rack in order to avoid the risk of personal injury and material damage.

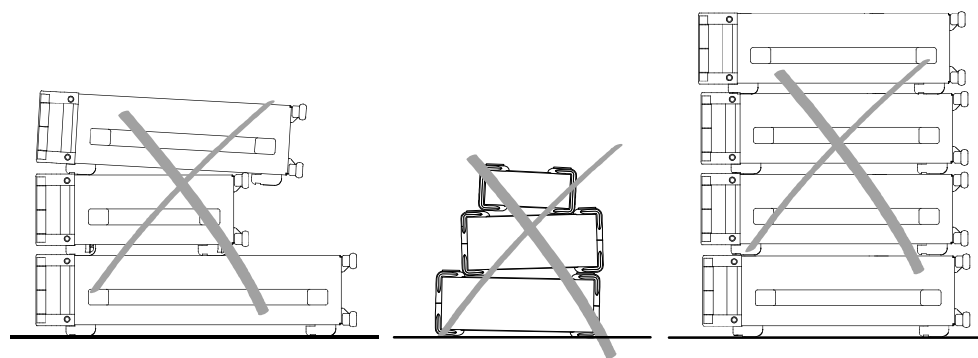
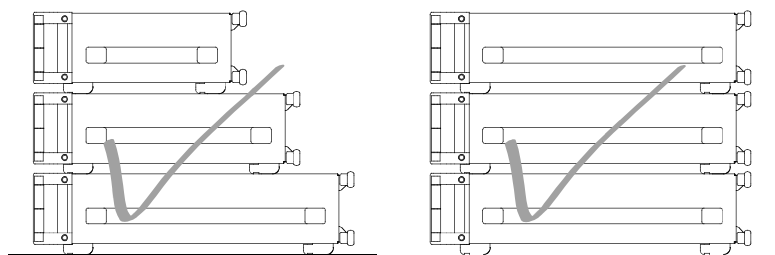

Incorrect order

Incompatible feet

Too many instruments stacked



## Informaciones de seguridad para el amontonamiento de aparatos

### **⚠ ADVERTENCIA**

#### **Peligro de heridas**

Los aparatos pueden desplazarse al ser amontonados.

Posicionar los aparatos sobre una superficie estable y lisa. Amontonar los aparatos por orden de su tamaño. No amontonar nunca más de tres aparatos uno sobre el otro. Los aparatos solamente deberán ser amontonados, si los piés y la caja del aparato correspondiente hacen posible amontonarlos de forma horizontal. Si no se cumplen estas condiciones, deberán ser montados los aparatos en una caja apta para este propósito. De esta manera evitarán el riesgo de daños en personas y daños en el aparato.

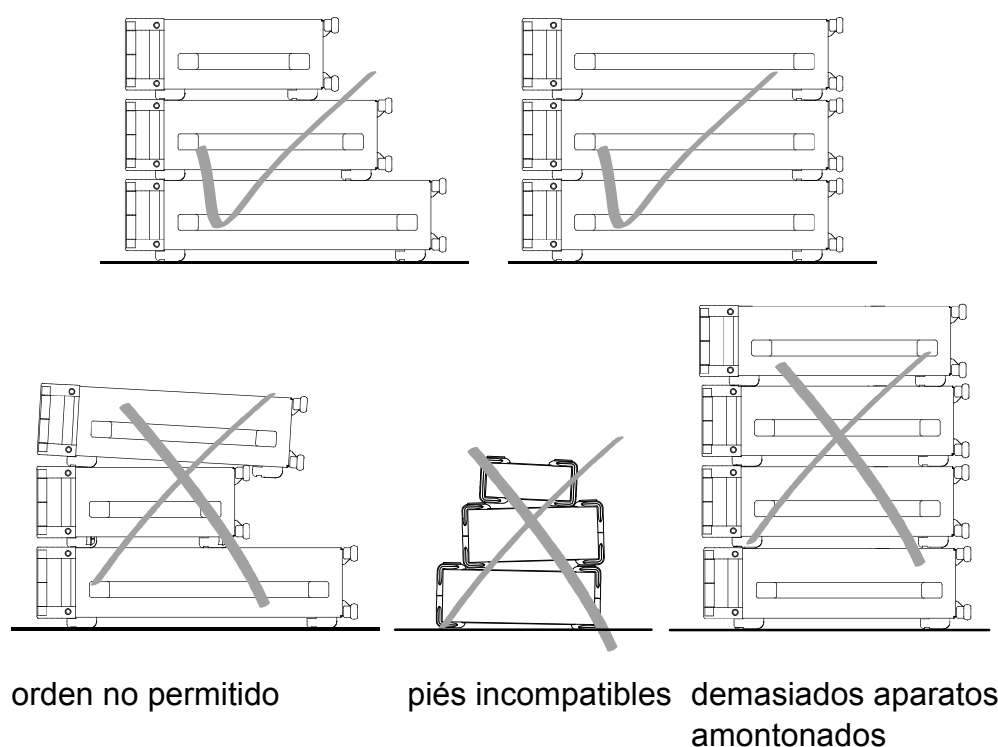

# Customer Support

## Technical support – where and when you need it

For quick, expert help with any Rohde & Schwarz equipment, contact one of our Customer Support Centers. A team of highly qualified engineers provides telephone support and will work with you to find a solution to your query on any aspect of the operation, programming or applications of Rohde & Schwarz equipment.

## Up-to-date information and upgrades

To keep your instrument up-to-date and to be informed about new application notes related to your instrument, please send an e-mail to the Customer Support Center stating your instrument and your wish.

We will take care that you will get the right information.

### Europe, Africa, Middle East

Phone +49 89 4129 12345  
[customersupport@rohde-schwarz.com](mailto:customersupport@rohde-schwarz.com)

### North America

Phone 1-888-TEST-RSA (1-888-837-8772)  
[customer.support@rsa.rohde-schwarz.com](mailto:customer.support@rsa.rohde-schwarz.com)

### Latin America

Phone +1-410-910-7988  
[customersupport.la@rohde-schwarz.com](mailto:customersupport.la@rohde-schwarz.com)

### Asia/Pacific

Phone +65 65 13 04 88  
[customersupport.asia@rohde-schwarz.com](mailto:customersupport.asia@rohde-schwarz.com)

### China

Phone +86-800-810-8228 /  
+86-400-650-5896  
[customersupport.china@rohde-schwarz.com](mailto:customersupport.china@rohde-schwarz.com)



# Qualitätszertifikat

## Certificate of quality

## Certificat de qualité

Certified Quality System  
**ISO 9001**

Certified Environmental System  
**ISO 14001**

### Sehr geehrter Kunde,

Sie haben sich für den Kauf eines Rohde & Schwarz-Produktes entschieden. Sie erhalten damit ein nach modernsten Fertigungsmethoden hergestelltes Produkt. Es wurde nach den Regeln unseres Qualitätsmanagementsystems entwickelt, gefertigt und geprüft. Das Rohde & Schwarz-Qualitätsmanagementsystem ist unter anderem nach ISO9001 und ISO 14001 zertifiziert.

### Der Umwelt verpflichtet

- Energie-effiziente, RoHS-konforme Produkte
- Kontinuierliche Weiterentwicklung nachhaltiger Umweltkonzepte
- ISO 14001-zertifiziertes Umweltmanagementsystem

### Dear customer,

You have decided to buy a Rohde & Schwarz product. You are thus assured of receiving a product that is manufactured using the most modern methods available. This product was developed, manufactured and tested in compliance with our quality management system standards. The Rohde & Schwarz quality management system is certified according to standards such as ISO9001 and ISO14001.

### Environmental commitment

- Energy-efficient products
- Continuous improvement in environmental sustainability
- ISO 14001-certified environmental management system

### Cher client,

Vous avez choisi d'acheter un produit Rohde & Schwarz. Vous disposez donc d'un produit fabriqué d'après les méthodes les plus avancées. Le développement, la fabrication et les tests respectent nos normes de gestion qualité. Le système de gestion qualité de Rohde & Schwarz a été homologué, entre autres, conformément aux normes ISO9001 et ISO 14001.

### Engagement écologique

- Produits à efficience énergétique
- Amélioration continue de la durabilité environnementale
- Système de gestion de l'environnement certifié selon ISO 14001





이 기기는 업무용(A급) 전자파  
적합기기로서 판매자 또는  
사용자는 이 점을 주의하시기  
바라며, 가정외의 지역에서  
사용하는 것을 목적으로 합니다.



**ROHDE & SCHWARZ**

1171.0500.78-01



**ROHDE & SCHWARZ**  
EC Certificate of Conformity



Certificate No.: 2007-08

This is to certify that:

Equipment type	Stock No.	Designation
DVM50	2085.1900.03	MPEG2 Monitoring System
DVM100	2085.1600.03	
DVM120	2085.1700.03	
DVM-B1	2085.3283.02	Analyzer Board
DVM-B53	2085.5657.02	DVB-T / DVB-H Receiver Module
DVM-B520	2085.5640.02	Integration Set for DVM-B52

complies with the provisions of the Directive of the Council of the European Union on the approximation of the laws of the Member States

- relating to electrical equipment for use within defined voltage limits (2006/95/EC)
- relating to electromagnetic compatibility (2004/108/EC)

Conformity is proven by compliance with the following standards:

EN 61010-1 : 2001  
EN 61326 : 1997 + A1 : 1998 + A2 : 2001 + A3 : 2003  
EN 55011 : 1998 + A1 : 1999 + A2 : 2002, Klasse B  
EN 61000-3-2 : 2000 + A2 : 2005  
EN 61000-3-3 : 1995 + A1 : 2001

For the assessment of electromagnetic compatibility, the limits of radio interference for Class B equipment as well as the immunity to interference for operation in industry have been used as a basis.

Affixing the EC conformity mark as from 2007

**ROHDE & SCHWARZ GmbH & Co. KG**  
**Mühldorfstr. 15, D-81671 München**

Munich, 2008-07-15

Central Quality Management MF-QZ / Radde



**ROHDE & SCHWARZ**  
EC Certificate of Conformity



Certificate No.: 2007-09

This is to certify that:

Equipment type	Stock No.	Designation
DVM100L	2112.7050.02	MPEG2 Monitoring System
DVM-B1	2085.3283.02	Analyzer Board
DVM-B53	2085.5657.02	DVB-T / DVB-H Receiver Module
DVM-B520	2085.5640.02	Integration Set for DVM-B52
DVM-B60	2085.5586.02	DC/DC 48V Converter

complies with the provisions of the Directive of the Council of the European Union on the approximation of the laws of the Member States

- relating to electrical equipment for use within defined voltage limits (2006/95/EC)
- relating to electromagnetic compatibility (2004/108/EC)

Conformity is proven by compliance with the following standards:

EN 61010-1 : 2001  
EN 61326-1:2006  
EN 61326-2-1:2006  
EN 55011:2007 + A2:2007  
EN 61000-3-2:2006 +A1:2009 + A2:2009  
EN 61000-3-3:2008

For the assessment of electromagnetic compatibility, the limits of radio interference for Class B equipment as well as the immunity to interference for operation in industry have been used as a basis.

Affixing the EC conformity mark as from 2007

**ROHDE & SCHWARZ GmbH & Co. KG**  
Mühldorfstr. 15, D-81671 München

Munich, 2011-03-02

Central Quality Management GF-QP / Radde



Certificate No.: 2007-50

This is to certify that:

Equipment type	Stock No.	Designation
DVM-B30	2085.5570.02	Video and Audio Hardware Decoder
DVM-B50	2085.5605.02	Demodulator Module
DVM-B51	2085.5611.02	DVB-S / DVB-S2 Receiver Module
DVM-B52	2085.5628.02	DVB-T / DVB-H Receiver Module
DVM-B500	2085.5634.02	RF Carrier Board

complies with the provisions of the Directive of the Council of the European Union on the approximation of the laws of the Member States

- relating to electromagnetic compatibility (2004/108/EC)

Conformity is proven by compliance with the following standards:

EN 61326 : 1997 + A1 : 1998 + A2 : 2001 + A3 : 2003  
EN 55011 : 1998 + A1 : 1999 + A2 : 2002, Class A  
EN 61000-3-2 : 2000 + A2 : 2005  
EN 61000-3-3 : 1995 + A1 : 2001

For the assessment of electromagnetic compatibility, the limits of radio interference for Class A equipment as well as the immunity to interference for operation in industry have been used as a basis.

Affixing the EC conformity mark as from 2007

**ROHDE & SCHWARZ GmbH & Co. KG**  
Mühldorfstr. 15, D-81671 München

Munich, 2007-08-23

Central Quality Management MF-QZ / Radde

# Table of Contents

<b>1 Putting into Operation .....</b>	<b>1.1</b>
<b>1.1 Notes on Putting into Operation .....</b>	<b>1.1</b>
1.1.1 Unpacking the Instrument .....	1.1
1.1.2 Positioning the Instrument.....	1.2
1.1.3 AC Supply .....	1.2
1.1.4 DC Supply .....	1.3
1.1.5 EMC Safety Precautions .....	1.4
1.1.6 Fuses .....	1.4
1.1.7 Installation in a 19" Rack.....	1.5
<b>1.2 Switching the Instrument On and Off.....</b>	<b>1.6</b>
1.2.1 Switch-On State .....	1.6
<b>2 Introduction to the R&amp;S DVM Basic System .....</b>	<b>2.1</b>
<b>2.1 Legend for Front View .....</b>	<b>2.1</b>
2.1.1 Front Panel of R&S DVM100L .....	2.1
2.1.2 Front Panel of R&S DVM120 .....	2.3
2.1.3 Front Panel of R&S DVM50 .....	2.3
<b>2.2 Legend for Rear View.....</b>	<b>2.4</b>
2.2.1 Rear Panel of R&S DVM100L .....	2.4
2.2.2 Rear Panel of R&S DVM120 .....	2.8
2.2.3 Rear Panel of R&S DVM50 .....	2.8
2.2.4 Setting Up and Configuring a New R&S DVM System.....	2.8
<b>2.3 Notes on Putting into Operation R&amp;S DVM50.....</b>	<b>2.12</b>
2.3.1 System Requirements.....	2.12
2.3.2 Installing/Uninstalling DVM Controller Software .....	2.12
2.3.3 Configuring the Device .....	2.12
2.3.4 Restoring the Default Device Settings.....	2.13



2.3.5	Setting the Network Parameters .....	2.14
<b>2.4</b>	<b>Notes on the Operating System and Firmware Update.....</b>	<b>2.17</b>
2.4.1	Installation of the Software .....	2.17
2.4.2	Write Protection of the Hard Disk .....	2.17
2.4.3	Setting the System Time .....	2.18
2.4.4	Checking the Analyzer Time .....	2.18
2.4.5	Linking the System Time to an External Time Server.....	2.19
2.4.6	Configuring an External Keyboard .....	2.20
2.4.7	Firmware Update.....	2.21
2.4.8	Recovery and Backup Partition .....	2.22
<b>2.4</b>	<b>Launching the R&amp;S DVM Analyzer Application and Creating a Basic Configuration.....</b>	<b>2.33</b>
2.4.1	Launching the R&S DVM Analyzer Application .....	2.33
2.4.2	Creating a Basic Configuration.....	2.33
2.4.3	The R&S DVM Measurement Screen and its Operating Elements .....	2.34
2.4.4	Indication of Signal and Error States .....	2.36
2.4.5	The R&S DVM Measurement Groups .....	2.38

# Documentation Overview

The user documentation for the R&S <Product type> is divided as follows:

## Quick Start Guide

The printed Quick Start Guide is delivered with the R&S DVM. On CD-ROM, the Quick Start Guide is part of the manual provided in the PDF format. The Quick Start Guide contains the following information:

- Chapter 1

This chapter contains all information about putting the instrument into operation (unpacking, connection to AC supply, switching on and off), function check, installation of the instrument in a rack, and describes default settings.

- Chapter 2

This chapter describes the instrument's controls and the connectors using front- and rear-panel views. Connection of external devices such as printer, keyboard, mouse, and monitor are also explained. Specifications for the interfaces are contained in the data sheet.

## Operating Manual

The Operating Manual is part of the manual provided in PDF format on the CD-ROM. It contains the following information:

- Chapter 3

Explains the operating concept of the R&S DVM, the individual menus and functions, the complementary features and options.

- Chapter 4

Introduces into remote operation and describes how to use the remote operation commands.

- Chapter 5

Gives a detailed descriptions of how the transport stream measurement functions have been implemented in the R&S DVM.

- Chapter 6

Describes the interfaces of the R&S DVM.

**Online Help**

The Online Help is available on the R&S DVM and is called by means of the HELP hardkey. It includes all information provided by the Quick Start Guide and the Operating Manual. For detailed information on using the Online Help refer to Chapter "Manual Operation" in the Operating Manual or the Online Help.

**CD-ROM**

The CD-ROM is delivered with the instrument. It provides the Manuals for the different models in PDF format and the Installation Instructions for options.

# 1 Putting into Operation

## 1.1 Notes on Putting into Operation

### NOTICE

Prior to putting the instrument into operation, check the following:

- The instrument cover is in place and screwed on.
- Vent holes are not obstructed.
- The signal levels at the inputs do not exceed permissible limits.
- The outputs of the instrument are not overloaded or incorrectly connected.

Any non-compliance with these precautions may cause damage to the instrument.

### 1.1.1 Unpacking the Instrument

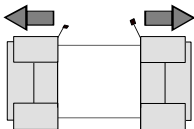

Remove  
protective  
covers

1. After unpacking the instrument, check the supplied equipment against the delivery note and the lists of accessories to make sure that it is complete.
2. Remove the two protective covers at the front and the rear and carefully check the instrument for possible damage.

Should there be any damage, inform the carrier immediately and keep the packaging to support all subsequent claims. The original packaging is also useful for transporting or shipping the instrument later on. Keep at least the two protective covers to protect front and rear panel and the connectors from being damaged.

## 1.1.2 Positioning the Instrument

For use in the lab or on a workbench, fold out the feet at the bottom of the unit.

---

**⚠ WARNING****Risk of injuries**

Before positioning the instrument, read the safety instructions for instruments with fold-out feet at the beginning of this manual carefully.

---

## 1.1.3 AC Supply

The instrument can be operated from 100 V to 120 V and 200 V to 240 V AC at frequencies from 50 Hz to 60 Hz. The AC supply connector is located at the rear of the unit. The auto ranging function automatically adapts to the applied voltage by selecting one of the two permissible voltage ranges. Adjusting the instrument to a particular AC supply voltage is therefore not required.

### 1.1.4 DC Supply



The instrument is optionally equipped with a -48 V DC input for the power supply. The permitted input voltage range is -38 V to -65 V.

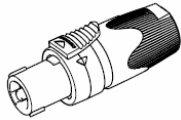

The maximum current drain depends on the input voltage and has the following values:

- up to 3.6 A at -38 V
- up to 2.1 A at -65 V

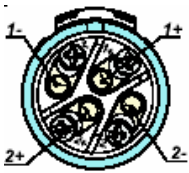

The instrument is supplied with a connector for the customer's power supply.

The allocation is as follows:

Pin 1+ =	open
Pin 1- =	ground-earth
Pin 2+ =	0 V (ground-power supply)
Pin 2- =	-48 V

#### **⚠ WARNING**

##### **Danger of shock hazard**

The DC power supply cable must not be longer than 20 m and must not be run outside the building. In this case, an external lightning protection system must be provided.

The used power supply (SELV) must fulfill the requirements for reinforced/double insulation for main supply circuits in accordance to

DIN/EN/IEC 61010-1 (UL61010B-1, CSA/CAN C22.2 Nr. 61010,1) or DIN/EN/IEC 60950-1 (UL60950-1, CSA/CAN C22.2 Nr. 60950-1).

Before switching on the instrument check the connection for correct polarity.

(+ = grounded).

### 1.1.5 EMC Safety Precautions

To prevent electromagnetic interference, the instrument must be operated only when closed and with all shielding covers fitted. Only suitable and shielded signal and control cables may be used. This applies in particular to cables that are connected to the ASI inputs and outputs. Depending on the data rate and the packet timing of the transport stream, high levels may occur sporadically within the signal spectrum. To avoid EMC problems, these cables should therefore have at least 80 dB to 1 GHz shielding. This is usually achieved by means of double-shielded cables.

### 1.1.6 Fuses

The AC input of the instrument is protected by two fuses (see type label). The fuses are located next to the main switch at the rear of the instrument.

**Figure 1-1: Fuses**



R&S® DVM50/100L/120

### 1.1.7 Installation in a 19" Rack

**NOTICE**

When the instrument is installed in a rack, make sure that the vents for air intake in the front and side panels and the air outlets at the instrument rear are not obstructed to avoid overheating of the instrument.

To mount the unit in a rack, remove the blue foot pads from the grey plastic part.

Do not undo the fastening screws in the unit feet.

*Figure 1-2: Foot pads*

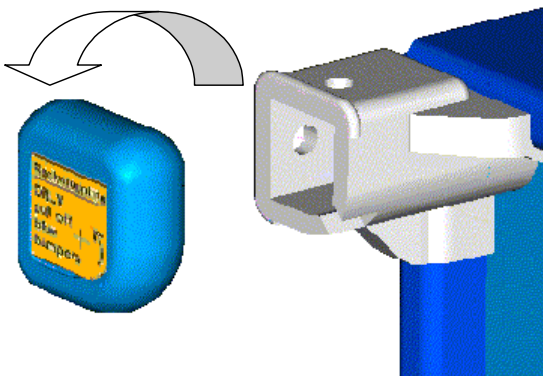



## 1.2 Switching the Instrument On and Off



### Switching on:

- ▶ Set switch to position I; the instrument is ready for operation.

### Switching off:

- ▶ Set switch to position 0.

### 1.2.1 Switch-On State

When the instrument is switched on, the status set when the instrument was previously switched off is automatically restored.

#### 1.2.1.1 Non-Volatile RAM

A battery-backed RAM is provided in the instrument for storing internal instrument data. The RAM and the system clock are powered from a lithium battery with a lifetime of approx. 5 years. When the battery is depleted, the stored data is lost. Changing the battery is described under Repairs in the Service Manual.

## 2 Introduction to the R&S DVM Basic System

This chapter introduces the operating concept and describes front and rear panels of the instrument with relevant control elements and connectors.

### 2.1 Legend for Front View

#### 2.1.1 Front Panel of R&S DVM100L

*Figure 2-1: Front panel of R&S DVM100L*

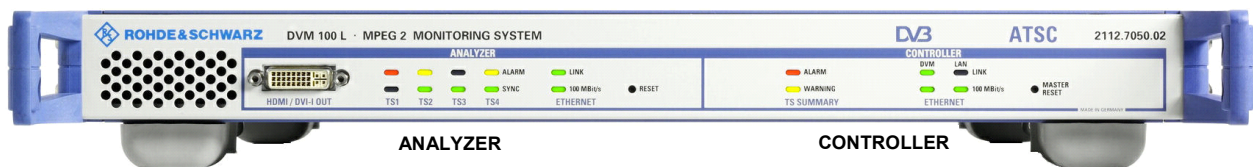

Model 03 instruments which are equipped with a hardware decoder include a DVI-I output on the front panel.

*Figure 2-2: HDMI/DVI-I OUT*

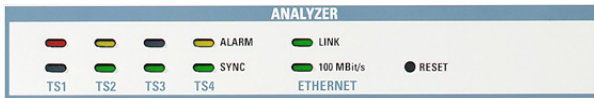

**Figure 2-3: Analyzer**

## TS1/TS2/TS3/TS4

Signal status of inputs 1 to 4

- **ALARM**

- off: no alarm
- red: no transport stream or alarm signal present
- yellow: an alarm signal was detected but is no longer active

- **SYNC**

- green: transport stream present
- off: no transport stream

## ETHERNET

Status of analyzer control

- **LINK**

- green: link established
- off: no connection

- **100 Mbit/s**

- green: max. data rate 100 Mbit/s
- off: max. data rate 10 Mbit/s

## RESET

Key for restarting the analyzer (may be required during setup or extension of a system to register the analyzers). Actuate by means of a blunt pin.

## 2.1.2 Front Panel of R&S DVM120

Figure 2-4: Front panel of R&S DVM120



The LEDs of the two analyzers are identical to those of the R&S DVM100L analyzer (see above).

Model 03 instruments which are equipped with a hardware decoder include a DVI-I output on the front panel (see      ).

## 2.1.3 Front Panel of R&S DVM50

Figure 2-5: Front panel of R&S DVM50

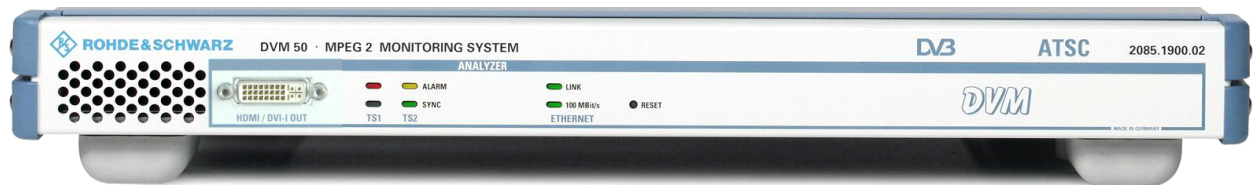

The LEDs of the analyzer are identical to those of the R&S DVM100L analyzer (see above).

Model 03 instruments which are equipped with a hardware decoder include a DVI-I output on the front panel (see      ).

## 2.2 Legend for Rear View

### 2.2.1 Rear Panel of R&S DVM100L

Figure 2-6: Rear panel of R&S DVM100L



#### Controller interfaces

##### ALARM LINES



15-contact female connector

12 relay outputs that can be assigned to one or more (ORed) events.

##### VGA MONITOR



15-contact female connector for a PC monitor.

##### USB



##### 100 BASE-T



RJ-45 female connector

for remote control of the entire system via the network.

**100 BASE-T**

RJ-45 female connector of controller for connecting one or more analyzers via a local private network.



The "private network" is an IP-based Ethernet network that is allowed to contain only R&S DVM analyzers. This is the only way to achieve the required data rate. On the other hand, the R&S DVM controller contains a DHCP server for automatic assignment of IP addresses which might create conflicts if the public network contains a DHCP server as well.

**ANALYZER interfaces****100 BASE-T**

RJ-45 female connector of analyzer for connection to the controller via a local private network.

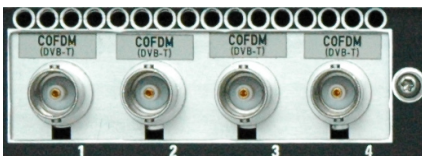
**Optional signal interfaces****RF signal inputs**

For instruments equipped with an RF interface, the female RF input connectors are located here. The design depends on the modulation standard.

- BNC male connector for R&S DVM-B50 (DVB-C, J83.A/B and R&S DVM-B52 (DVB-T)
- F male connector for R&S DVM-B51

For instruments equipped with a hardware decoder, the signal outputs for analog audio and digital video SDI are located here.



Optional – for future extensions

### TS inputs on instruments without RF receiver

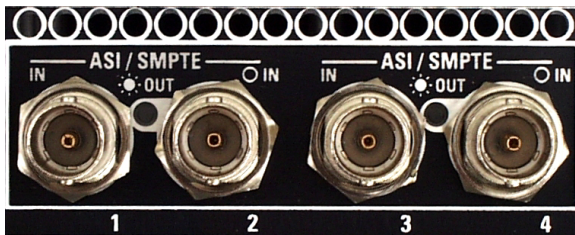

### TS ASI / SMPTE 310

BNC connectors, female

Transport stream input and output

- ASI (asynchronous serial interface) in line with DVB DOCUMENT A010 and
- SMPTE-310M (synchronous serial) (19.392658 Mbit/s).

(1) TS input 1

(2) TS input 2 or alternatively TS output  
(TS from input 1 actively looped through - LED OUT)

(3) TS input 3

(4) TS input 4 or alternatively TS output  
(TS from input 3 actively looped through - LED OUT)

The use of the inputs depends on the option (see data sheet).

### TS inputs on instruments with RF receiver



## TS ASI / SMPTE 310

BNC connectors, female

Transport stream input and output

- ASI (asynchronous serial interface) in line with DVB DOCUMENT A010 and
- SMPTE-310M (synchronous serial) (19.392658 Mbit/s).

For instruments equipped with an RF receiver, all four transport stream interfaces can be configured either as inputs or outputs. Thus, it is possible to output the demodulated transport stream of an RF receive module via an unused TS input interface.

## AC supply connector, switch and fuses



100 .. 240V

50 .. 60 Hz/60VA

F1/F2:IEC127

T2.0 H/250V

Automatic voltage selection.

### To replace the fuses

1. Disconnect the power plug and open the fuse cover on the side.

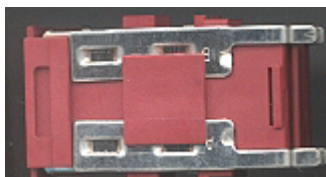

2. Remove defective fuse from the fuse holder and replace it.



## 2.2.2 Rear Panel of R&S DVM120

Figure 2-7: Front panel of R&S DVM120



The interfaces of the two analyzers are identical to those of the R&S DVM100L analyzer (see above).

## 2.2.3 Rear Panel of R&S DVM50

Figure 2-8: Front panel of R&S DVM50



The interfaces of the analyzer are identical to those of the R&S DVM100L analyzer (see above).

## 2.2.4 Setting Up and Configuring a New R&S DVM System

The base component of a R&S DVM system is the R&S DVM100L. It contains a controller and an analyzer for monitoring up to 4 transport streams. If more transport streams have to be analyzed, the system can be expanded by adding one or two R&S DVM120.

The analyzers are connected to the controller via an IEEE802.3 Ethernet-based private network. The base system – which contains only one analyzer – can be directly connected by means of the crossed Ethernet cable supplied with the R&S DVM100L. Expanded systems – containing several analyzers - are connected via an Ethernet hub.

Operation is via an XVGA monitor with keyboard and mouse connected to the controller.

After interconnecting the hardware, a basic configuration has to be performed so that the connected analyzers are made known to the system and can be used for analysis.

### 2.2.4.1 System with R&S DVM100L

If a system contains only one R&S DVM100L, the analyzer can be directly connected to the controller. A crossed Ethernet cable such as the one supplied with the R&S DVM100L must be used in this case.

**Figure 2-9: Connections of basic configuration of R&S DVM100L**

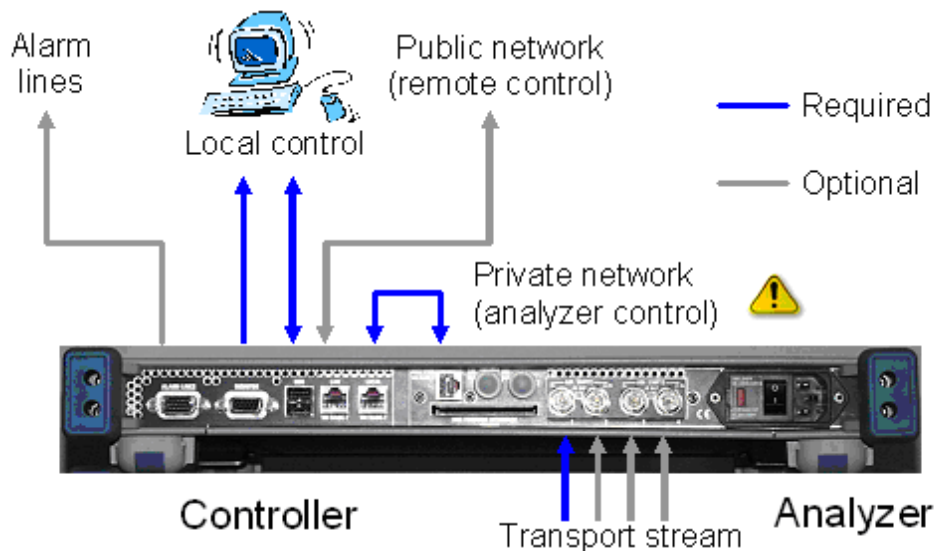

The "private network" is an IP-based Ethernet network that is allowed to contain only R&S DVM analyzers. This is the only way to achieve the required data rate. On the other hand, the R&S DVM controller contains a DHCP server for automatic assignment of IP addresses which might create conflicts if the public network contains a DHCP server as well.

A local control monitor is not always required for operation of the R&S DVM. The system can also be controlled via the remote-control interface. For further information refer to chapter "Remote Control".

2.2.4.2 System with R&S DVM100L and R&S DVM120

In a system containing both the R&S DVM100L and the R&S DVM120, the analyzers are connected to the controller via an Ethernet hub. All 100 Mbit/s-compatible hubs in line with standard IEEE802.3 can be used. We recommend to use hubs with automatic identification of the line configuration. If such a hub is not available, uncrossed Ethernet cables must be used.

Figure 2-10: Connections of an R&S DVM100L + R&S DVM120 basic configuration

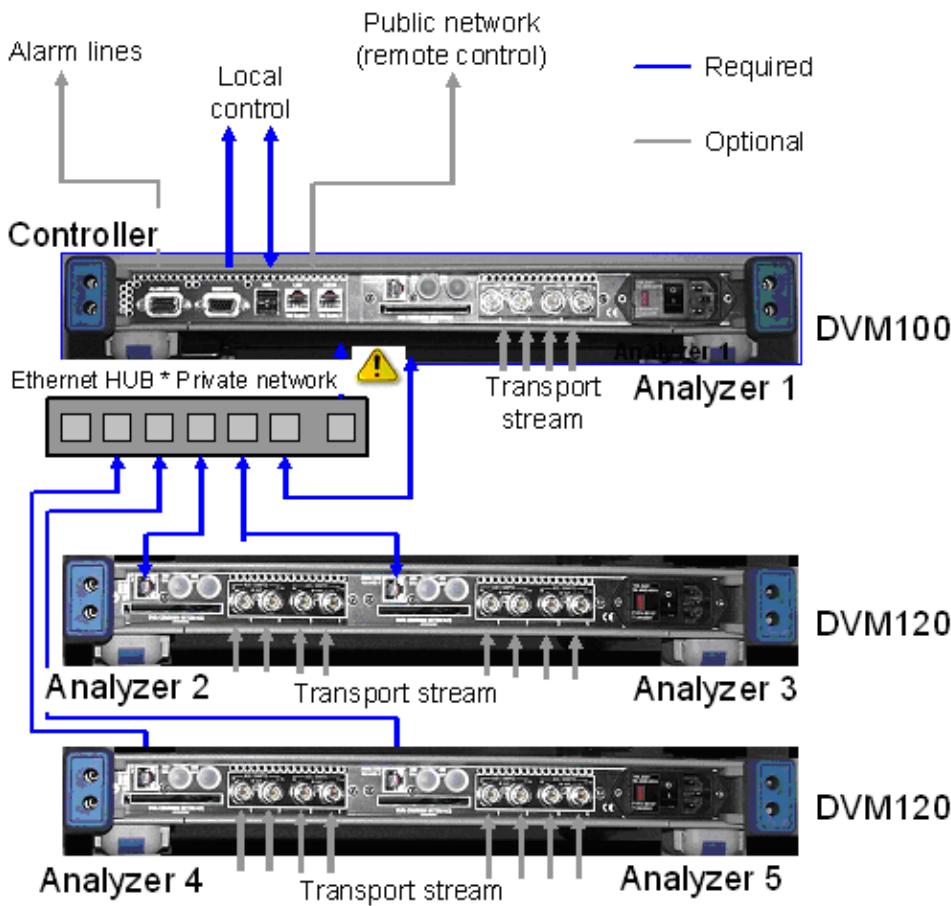

The "private network" is an IP-based Ethernet network that is allowed to contain only R&S DVM analyzers. This is the only way to achieve the required data rate. On the other hand, the R&S DVM controller contains a DHCP server for automatic assignment of IP addresses which might create conflicts if the public network contains a DHCP server as well.

### 2.2.4.3 System with R&S DVM50 and PC

In a system containing both the R&S DVM50 the analyzer are connected to the controller via an Ethernet cable.

**Figure 2-11: System with R&S DVM50 and PC**



The "private network" is an IP-based Ethernet network that is allowed to contain only R&S DVM analyzers. This is the only way to achieve the required data rate. On the other hand, the R&S DVM controller contains a DHCP server for automatic assignment of IP addresses which might create conflicts if the public network contains a DHCP server as well.

## 2.3 Notes on Putting into Operation R&S DVM50

To operate the device, you must have a PC running Microsoft Windows XP that is equipped with an Ethernet adapter. This section describes how to install DVM Controller Software on the PC and how to configure the R&S DVM 50 for operation in the network.

### 2.3.1 System Requirements

We recommend the following minimum requirements for the DVM Controller PC:

- Intel Pentium III, 700 MHz
- 256 MByte RAM, 1 GByte free hard disk space
- Screen resolution 1024 x 768
- Microsoft Windows XP Service Pack 1

### 2.3.2 Installing/Uninstalling DVM Controller Software

For details refer to the release notes.

### 2.3.3 Configuring the Device

Before the device can be remotely controlled from a PC, the network parameters must be set using the provided *DVM Analyzer Network Configuration* program. These settings are stored permanently in the device. Reconfiguration of the R&S DVM 50 is then necessary only if the network environment changes. The R&S DVM 50 must be in its default state to set the network parameters.

### 2.3.4 Restoring the Default Device Settings

If the R&S DVM 50 is already in its default state (as is the case when the device is first delivered), you can skip to the following section.

To restore the default device settings:

- Turn on the device. A few seconds later, all TS LEDs (ALARM and SYNC) should light yellow. While all LEDs are still lit yellow, turn off the device.
- Repeat this step a second time.

The device is now in its default state and the network parameters can be set.



Instead of the steps described above, you can also use a blunt object (such as a pen) to press the Reset key on the front of the device while the yellow TS LEDs are lit. Wait until the yellow LEDs have extinguished and lit again before pressing the Reset key a second time.

---

### 2.3.5 Setting the Network Parameters

To configure the network parameters, connect the R&S DVM 50 to a Windows XP PC using the provided crossed Ethernet cable. It does not matter whether the PC used for the network configuration is the same one that the R&S DVM 50 will run on later. You do have to ensure, though, that the PC used for the network configuration has a valid IP address.

1. Switch on the R&S DVM 50 and start the *DVM Analyzer Network Configuration.exe* program located in the `software_CD-Install\confi_tools` folder on the installation CD-ROM. This opens the following dialog box:

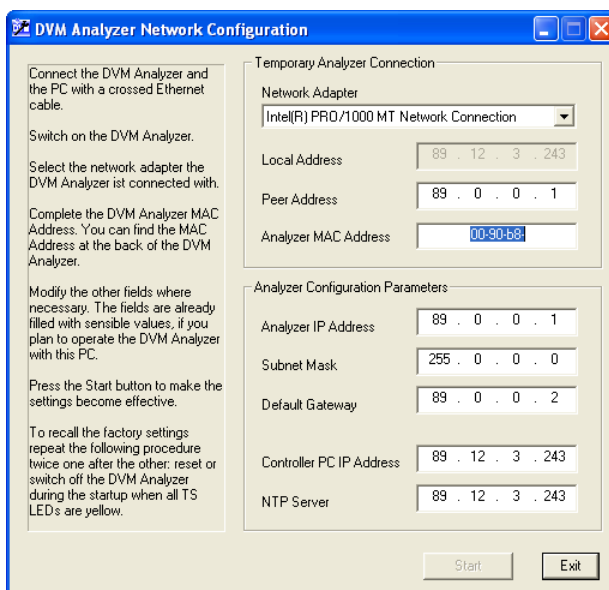

2. You might find that some of the entry fields are grayed out on your PC. If you have more than one network adapter installed on your PC, check to ensure that the adapter defined in the *Network Adapter* field is the one that is connected to the R&S DVM 50. If so, the *Local Address* field should contain the IP address for that adapter. It can take a few seconds after the R&S DVM 50 is switched on before the network connection is recognized. During this time, the entry fields will be grayed out.



If the entry fields are still grayed out after checking the above items, you should check the following:

- Is the device in the default state? If you are not sure, try to reset the R&S DVM 50 to its default state (see above).
- Did you use the crossed network cable that was provided with the device for the connection between the R&S DVM 50 and the PC? The network parameters can be set only with a crossed network cable that directly connects the R&S DVM 50 to the PC.
- Does the PC have a valid IP address? The PC's IP address should not be assigned dynamically during the network configuration.

Is a DHCP Server service or program running on the PC, or is the PC connected to a network that provides the DHCP service? Check to ensure that the R&S DVM 50 cannot access a DHCP service while you are setting the network parameters.

3. After the R&S DVM 50 is switched on, the entry fields are prefilled with valid values for the eventuality that the R&S DVM 50 will be run on this PC. In this case, you simply have to enter the *Analyzer MAC Address* that can be found on the rear panel of the R&S DVM 50. In all other instances, all entry fields in the *Analyzer Configuration Parameters* section must be completed individually:

- Network Adapter:  
Select the network adapter connected to the R&S DVM 50.
- Local Address:  
The IP address of the selected network adapter. This is filled in automatically by the program and is for informational purposes only.
- Peer Address:  
This IP address is temporarily assigned to the R&S DVM 50 while the network parameters are being set. This must be a valid IP address from the subnet range of the PC being configured. There normally is no reason to change the address provided here.
- Analyzer MAC Address:  
The MAC address or the Ethernet address of the R&S DVM 50. This address is found on the rear panel of the device and must be entered in the format XX-XX-XX-XX-XX-XX.
- Analyzer IP Address:  
This IP address is assigned to the R&S DVM 50 for operation. This setting is stored permanently.



- Subnet Mask:  
The subnet mask of the network in which the R&S DVM 50 will run. This setting is stored permanently.
- Default Gateway:  
The default gateway of the network in which the R&S DVM 50 will run. This setting is stored permanently.
- Controller PC IP Address:  
The IP address of the PC on which DVM Controller Software is installed. This setting is stored permanently.
- NTP Server:  
The IP address of an optional NTP server. This setting is stored permanently.

Refer also to the following section regarding the Network Time Protocol (NTP).

4. Finally, click *Start* to save the settings for the R&S DVM 50. If the *Start* button is unavailable, then at least one of the entry fields is incomplete. Successful completion of the configuration process is acknowledged with a confirmation dialog. The R&S DVM 50 can now be switched off. The new settings will take effect the next time the device is switched on.



You do not need to reset the R&S DVM 50 to its default state if you know the last IP address that was set in the R&S DVM 50, and if the configuring PC is in the same subnetwork as the R&S DVM 50. Simply enter the IP address of the R&S DVM 50 as the Peer Address in the appropriate entry field of the configuration program when setting the network parameters. In this case, you do not need the direct connection with the crossed network cable between the R&S DVM 50 and the configuring PC.

---

## 2.4 Notes on the Operating System and Firmware Update

### 2.4.1 Installation of the Software

---

**NOTICE**

Only software authorized by Rohde & Schwarz for use in the R&S DVM may be installed. In case of doubt, please contact your local Rohde & Schwarz representative.

- Changes to the system are only permissible in agreement with Rohde & Schwarz.
  - Updating the operating system, e.g. installing a service pack, is not allowed without permission.
- 

Otherwise the stability and performance of the system may be impaired. Rohde & Schwarz shall not assume any liability for faults caused by impermissible manipulations of the system.

For details on the installation refer to the release notes.

### 2.4.2 Write Protection of the Hard Disk

Model 02 instruments are equipped with write protection for the system's C:\ hard disk. This function is no longer supported as of model 03. Secure continuous operation is ensured even without write protection. You should also now refrain from activating write protection for old instruments as well.

For model 02 instruments, you can do this using the functions described in the release notes.

### 2.4.3 Setting the System Time

You can set the system time using the Windows Desktop.

#### Setting the time of day:

1. Open the Windows XP dialog selecting "Start" → "Settings" → "Control Panel" → "Date and Time"
2. Set the date and time.

#### Setting the regional and language options:

1. Open the Windows XP dialog selecting "Start" → "Settings" → "Control Panel" → "Regional and Language Options"
2. Select the country on the "Regional Options" tab under "Standards and formats".



This setting will directly affect only the time and date display in Windows XP Desktop. In order to synchronize the time references of the connected analyzers, the application must be restarted after the time is adjusted.

---

### 2.4.4 Checking the Analyzer Time

R&S DVM analysis boards have their own time reference. It is adjusted via an internal NTP server (NTP = Network Time Protocol) to the system time of the controller.

#### Checking the synchronization:

1. Open the R&S DVM dialog selecting "Help" → "Analyzer Info" → "Site Configuration"
2. On the "Analyzer Info" tab, select "Analyzer" and click on the "Show Info" button.
3. Under "Clock", check the time of day and status of the NTP synchronization.

Larger time deviations (e.g. after adjusting the system time) will require you to restart the application.

## 2.4.5 Linking the System Time to an External Time Server



Switch off the XP write protection before making a change!

It is possible to link the system time to an external time server of an IP network. To do this, you need to enter its IP address in the `C:\Windows\ntp.conf` file and declare it as “prefer”.

**Figure 2.4-1: An excerpt from `C:\Windows\ntp.conf`**

No link to an external server	Link to NTP server with IP address 120.34.56.78
<pre>..... # # server 127.0.0.1 prefer fudge 127.0.0.1 stratum 12 # #</pre>	<pre>..... # # <b>server 120.34.56.78 prefer</b> server 127.0.0.1 fudge 127.0.0.1 stratum 12 # #</pre>

## 2.4.6 Configuring an External Keyboard



Switch off the XP write protection before making a change!

If so desired, you can connect an external keyboard to the USB interface. When delivered, the R&S DVM is preconfigured for an English US keyboard.

### Changing to a different country code:

1. Open the Windows XP dialog selecting "Start" → "Settings" → "Control Panel" → "Regional and Language Options"
2. On the "Language" tab, click the "Details" button to open the "Text Services and Input Languages" dialog.
3. Click the "Add..." button to add the desired input language and desired keyboard layout.
4. Select from the available options and confirm your choice.
5. If several keyboard codes are configured, you can select among them using the Windows taskbar.



6. If no external keyboard is available, you can enter characters via a screen-based keyboard using the mouse. The screen-based keyboard is activated using the keyboard icon in the taskbar.

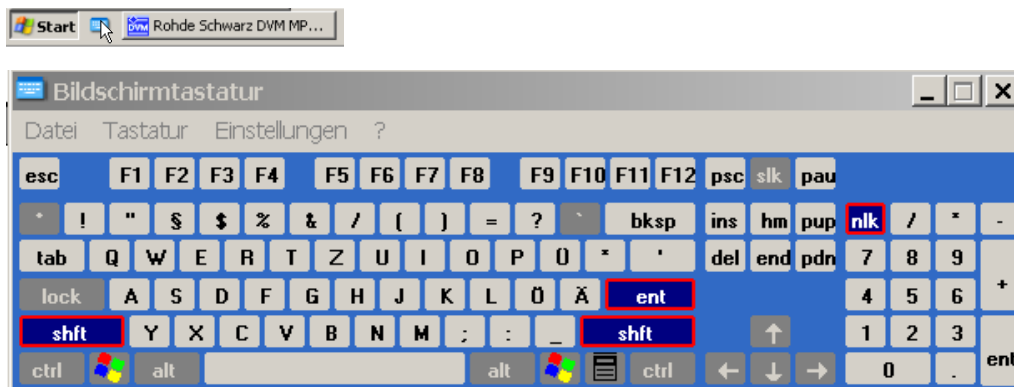

## 2.4.7 Firmware Update



Switch off the XP write protection before making a change!

For step-by-step instructions how to install a new R&S DVM firmware, refer to the release notes. If you do not follow these steps, there is a risk of losing information which identifies the instrument configuration.

### 2.4.7.1 Starting the Application and Checking the Version

1. Start the R&S DVM application using the "DVM" icon on the desktop.
2. In the site tree (top left), the connected analyzer will be displayed with the "[?]" icon so that it can be registered.

**Note:** It can take up to one minute for the analyzer to appear after an update.

3. Register the analyzer with the application:
  - a. Right-click on the icon and open the "Add Analyzer" dialog.
  - b. If desired, you can modify the proposed settings at this point. You can also wait until later to do this.
  - c. Close the "Add Analyzer" dialog and the "Site Configuration" dialog.
4. Check the version of the instrument firmware:
  - In the R&S DVM application → "Help" menu, select "About DVM" to open the "About DVM" dialog.
5. Checking the analyzer version:
  - In the R&S DVM application → "Help" menu, select "Analyzer Info..." to open the "Site Configuration" dialog.
  - On the "Analyzer Info" tab, select the desired analyzer and then click the "Show Info" button.

## 2.4.8 Recovery and Backup Partition

R&S DVM provides a backup and recovery partition. A backup of the factory system partition (C:\) is stored per default and can be recovered in case of a system crash.

In addition, backups of up to 5 images of partition C: can be stored. When recovered, the system partition (C:/) is deleted, formatted and newly written. The data partition (D:\) is not affected.



If the following message is displayed during backup or recovery, ignore it and do not restart your instrument. Select "No".



### 2.4.8.1 Prerequisite for the Recovery and Backup

As a prerequisite of a backup/restore process, in the BIOS settings, the hardware watchdog must be disabled. Otherwise the backup/restore process (which normally lasts about 10 to 15 minutes) will be terminated and fail due to a reboot issued by the watchdog after about 4 minutes.

#### Initiating the backup/restore process

1. Connect an external keyboard to the USB interface.
2. Switch the instrument off and on again.

## Notes on the Operating System and Firmware Update

3. Boot into the BIOS settings by pressing the DEL key of the external keyboard in the early boot phase when prompted at the bottom of the screen.

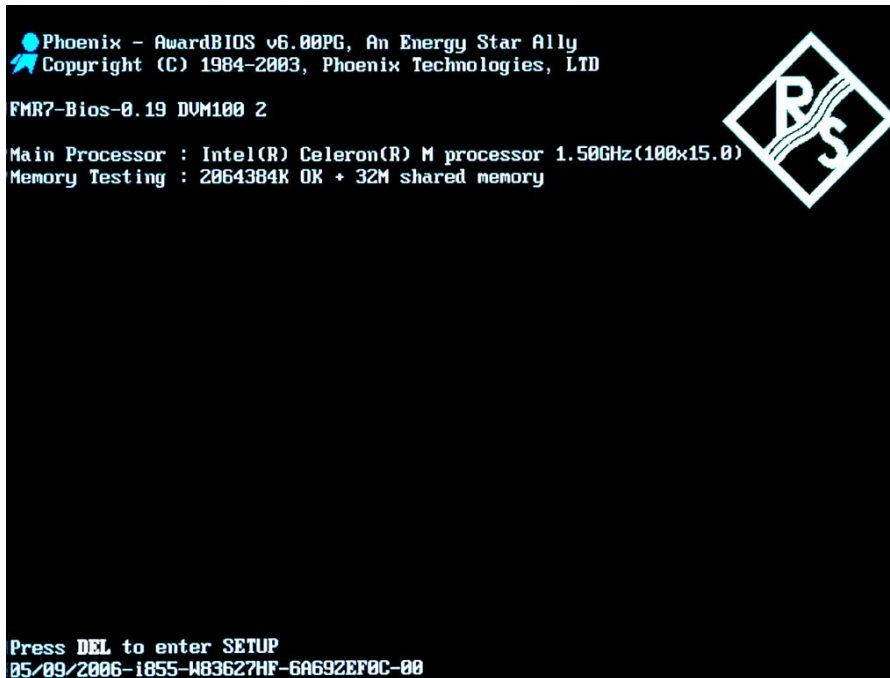

4. In the BIOS settings, select "Integrated Peripherals" using the UPARROW/DNARROW keys of the external keyboard and open the following page by pressing ENTER.





- In "Integrated Peripherals", change the "Watch Dog Timer Select" setting to "Disabled".

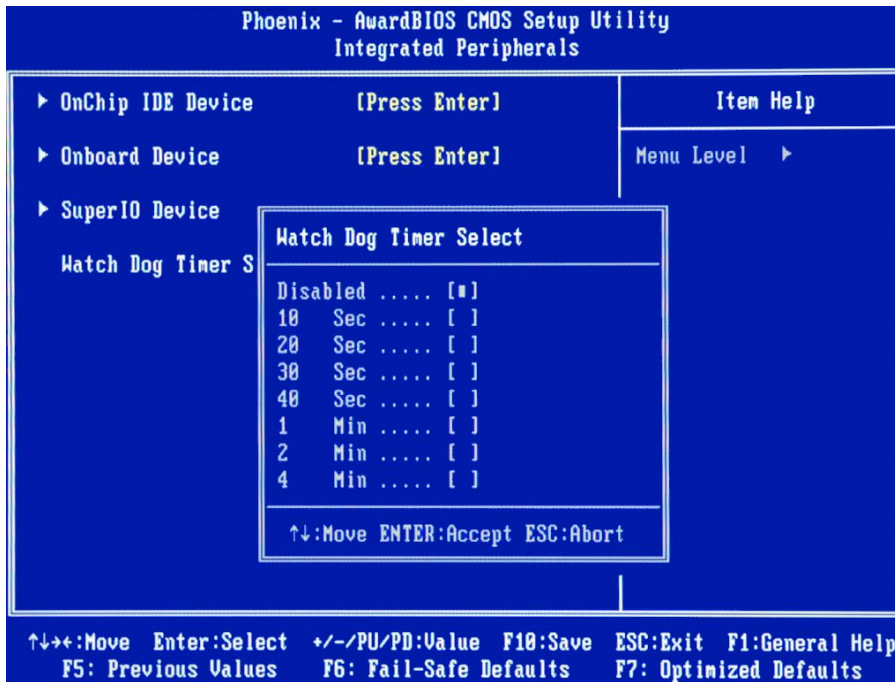

- Return to the main page and select "Save & Exit Setup" to store the changes and proceed with the system boot.
- In the boot screen, select "Backup/Recovery" and press ENTER.
- Press ENTER to open the "Windows XP Embedded Recovery and Backup Partition" dialog.

After a successful boot with the default option "Firmware" in the boot dialog or a restored backup, the hardware watchdog will automatically be re-enabled by the R&S DVM system software. Make sure that the required sequence as described above is not interrupted for some reason. Otherwise restart at step 2.

### 2.4.8.2 Displaying the Windows XP Recovery and Backup Partition Dialog



Before you perform a backup or recovery, make sure that the hardware watchdog is disabled. For details see chapter [2.4.8.1](#).

1. In the boot screen, select "Backup/Recovery" and press ENTER.

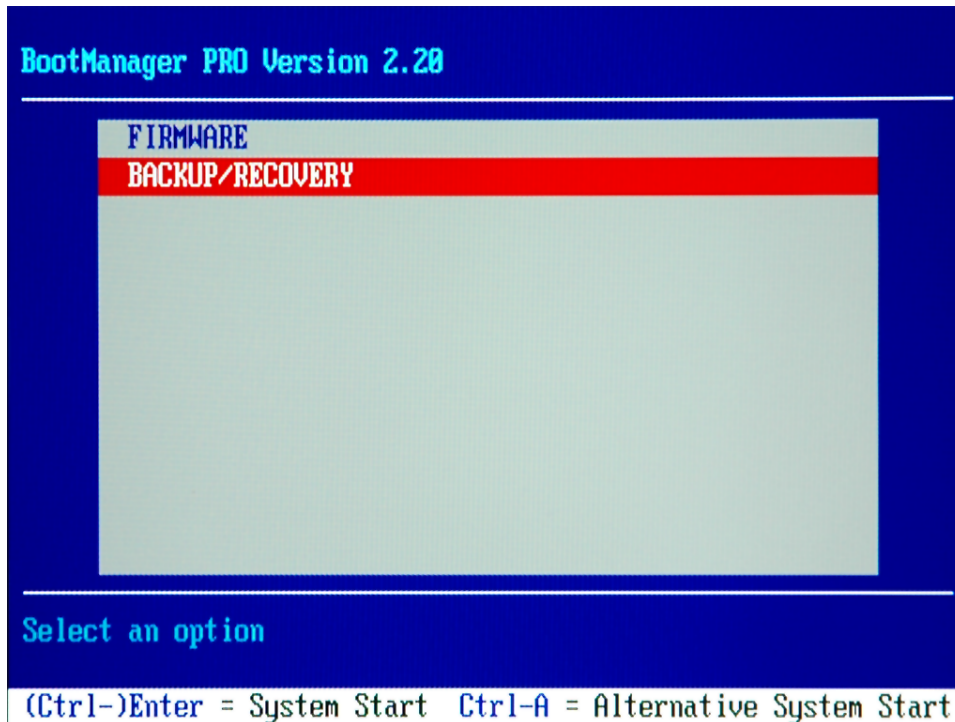

2. Press ENTER to open the "Windows XP Embedded Recovery and Backup Partition" dialog.

The dialog shows the available selections for the recovery and backup partition.

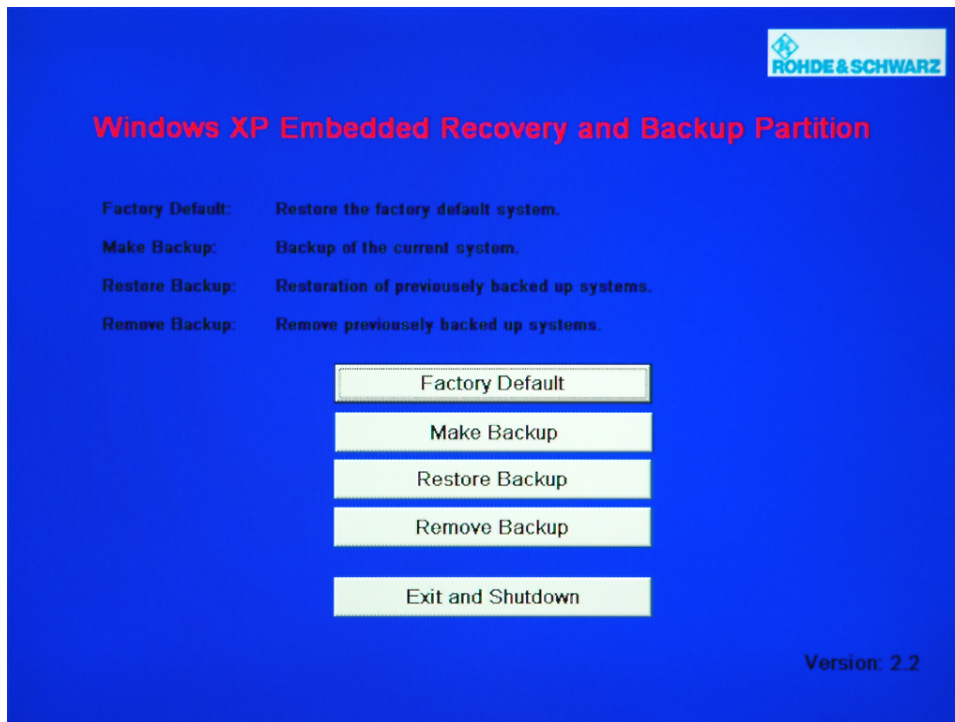

To continue see one of the following chapters:

- Backing Up the Current System Partition (chapter [2.4.8.3](#))
- Recovering the Selected Version of System Partition (chapter [2.4.8.4](#))
- Recovering the Factory Default (chapter [2.4.8.5](#))
- Deleting Backups (chapter [2.4.8.6](#))



In the Windows XP Embedded Recovery and Backup Partition dialog and all successive dialogs, you need a mouse to work with.

### 2.4.8.3 Backing Up the Current System Partition

1. Make sure that the hardware watchdog is disabled. For details see chapter [2.4.8.1](#).
2. In the "Windows XP Embedded Recovery and Backup Partition" dialog, click "Make Backup".

The "Make Backup" dialog is displayed. It shows the current versions of the firmware and the software platform.

3. Click "Make Backup".

After the backup, the "Windows XP Embedded Recovery and Backup Partition" dialog is displayed again.

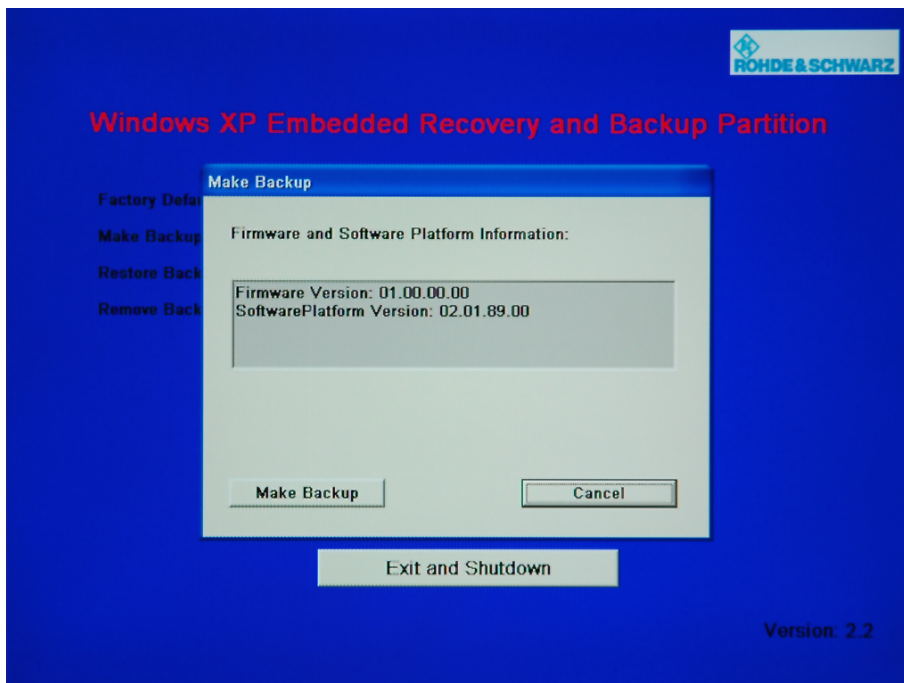

4. Click "Exit and Shutdown".
5. Turn off/on the R&S DVM manually.

#### 2.4.8.4 Recovering the Selected Version of System Partition

1. Make sure that the hardware watchdog is disabled. For details see chapter 2.4.8.1.
2. In the "Windows XP Embedded Recovery and Backup Partition" dialog, click "Restore Backup" to recover a selected version of the system partition.

The "Restore Backup" dialog is displayed. It shows the versions of the firmware and the software platform of the backup displayed under "Select Backup".

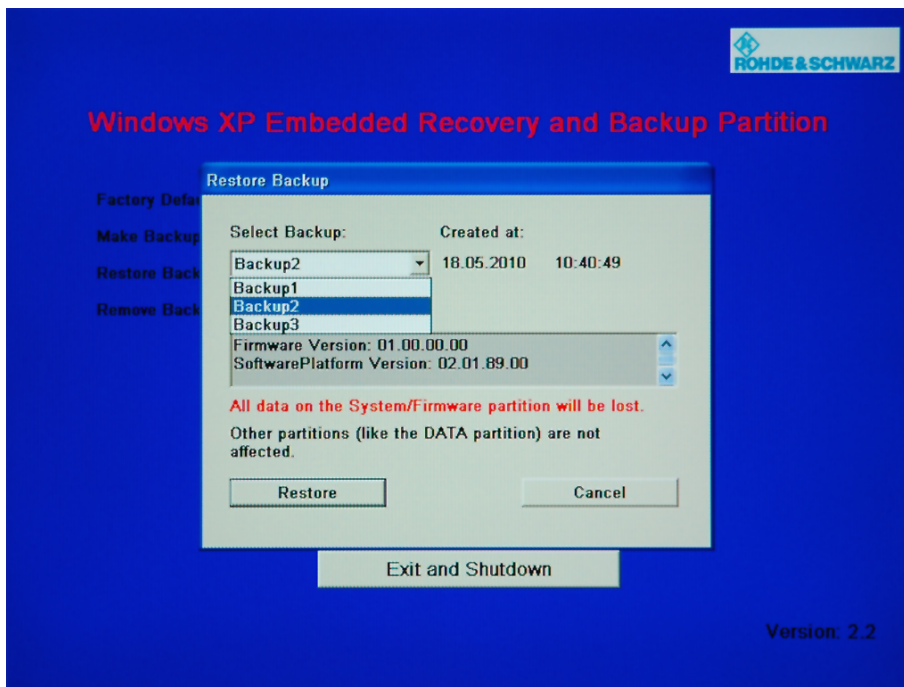

3. Under "Select Backup", select the backup to be restored.
4. Click "Restore" and follow the instructions.
5. After the recovery, turn off/on the R&S DVM manually.
6. It is recommended to reinstall the R&S DVM firmware after restoring any backup.
  - a. Uninstall by selecting "Start" → "Settings" → "Control Panel" → "Add or Remove Programs" and removing "R&S DVM100" or "R&S DVM400" in the Windows XP dialog.
  - b. Install the R&S DVM firmware afterwards as described in the release notes.

### 2.4.8.5 Recovering the Factory Default

1. Make sure that the hardware watchdog is disabled. For details see chapter 2.4.8.1.
2. In the "Windows XP Embedded Recovery and Backup Partition" dialog, click "Factory Default" to recover the factory version of the system partition.

The "Factory Default" dialog is displayed. It shows the versions of the firmware and the software platform on delivery.

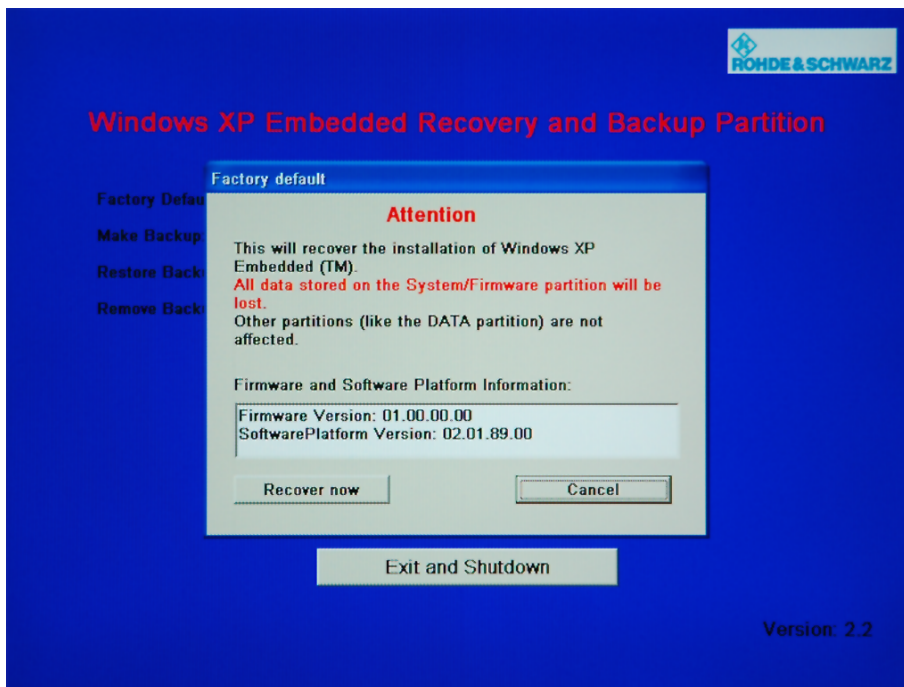

3. Click "Restore now" and follow the instructions.
4. After the recovery, turn off/on the R&S DVM manually.
5. It is recommended to reinstall the R&S DVM firmware after restoring any backup.
  - a. Uninstall by selecting "Start" → "Settings" → "Control Panel" → "Add or Remove Programs" and removing "R&S DVM100" or "R&S DVM400" in the Windows XP dialog.
  - b. Install the R&S DVM firmware afterwards as described in the release notes.

### 2.4.8.6 Deleting Backups

On the recovery partition, you can store up to five backups in addition to the factory default. To provide space for new backups, you may need to remove older backups. The factory default cannot be deleted.

1. Make sure that the hardware watchdog is disabled. For details see chapter [2.4.8.1](#).
2. In the "Windows XP Embedded Recovery and Backup Partition" dialog, click "Remove Backup" to delete a selected backup.

The "Remove Backup" dialog is displayed. It shows the versions of the firmware and the software platform of the selected backup.

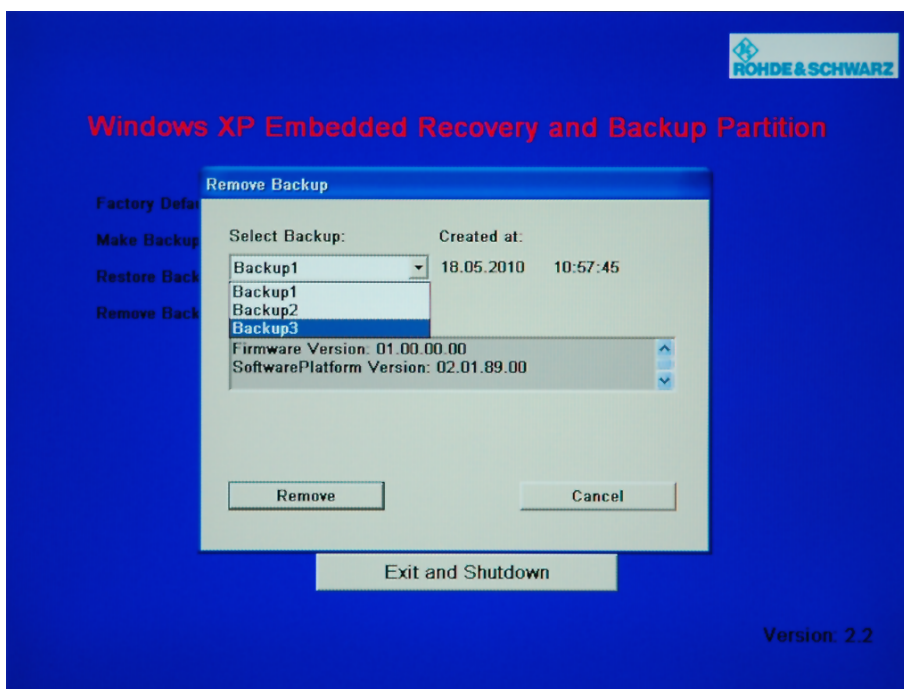

3. Under "Select Backup", select the backup to be deleted.
4. Click "Remove".

After the deletion, the R&S DVM returns to the "Remove Backup" dialog as long as backups are still available. If the last backup is deleted, the "Windows XP Recovery and Backup Partition" dialog is displayed again.

5. Click "Cancel" to return the "Windows XP Embedded Recovery and Backup Partition" dialog.
6. In the "Windows XP Embedded Recovery and Backup Partition" dialog, click "Exit and Shutdown".
7. Turn off/on the R&S DVM manually.

## 2.5 Launching the R&S DVM Analyzer Application and Creating a Basic Configuration

### 2.5.1 Launching the R&S DVM Analyzer Application

After power-up, the R&S DVM application is launched automatically.

- ▶ If the application was terminated manually, it can be restarted any time by double-clicking the R&S DVM program icon on the desktop.



- ▶ If you do not see the R&S DVM program icon on the desktop, you can find the program under "Start" → "Programs" → "Rohde & Schwarz" → "DVM"

### 2.5.2 Creating a Basic Configuration

After booting, the instrument automatically launches the R&S DVM application. If the currently used system has never been configured before, perform a basic configuration as described below:

1. In the "File" menu, select "New Site Configuration...".

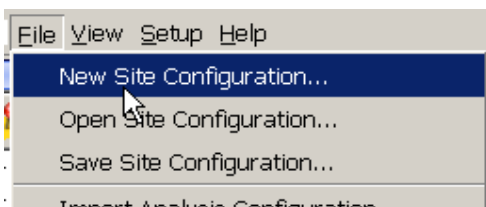

2. Select the desired TV standard from the list and specify the memory location and a name for the configuration file.

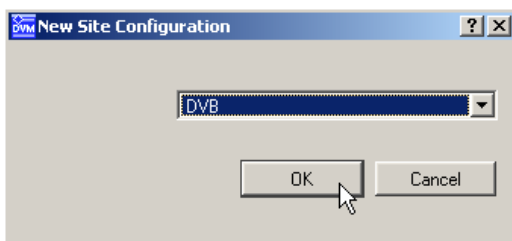

3. Start the configuration with "OK".



Launching the R&S DVM Analyzer Application and Creating a Basic Configuration

Figure 2.5-1: Site tree for an R&S DVM100/DVM120 system with an analysis board having two inputs

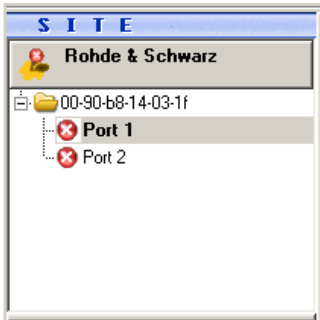

After successful configuration, all installed TS inputs are displayed in the site tree. The system is now ready for operation. The configuration can be adapted as required with the aid of corresponding setup menus. Appropriate names can be assigned to the inputs in the site tree, the order of the inputs can be determined and inputs can be organized in folders.

### 2.5.3 The R&S DVM Measurement Screen and its Operating Elements

Figure 2.5-2: The R&S DVM measurement screen

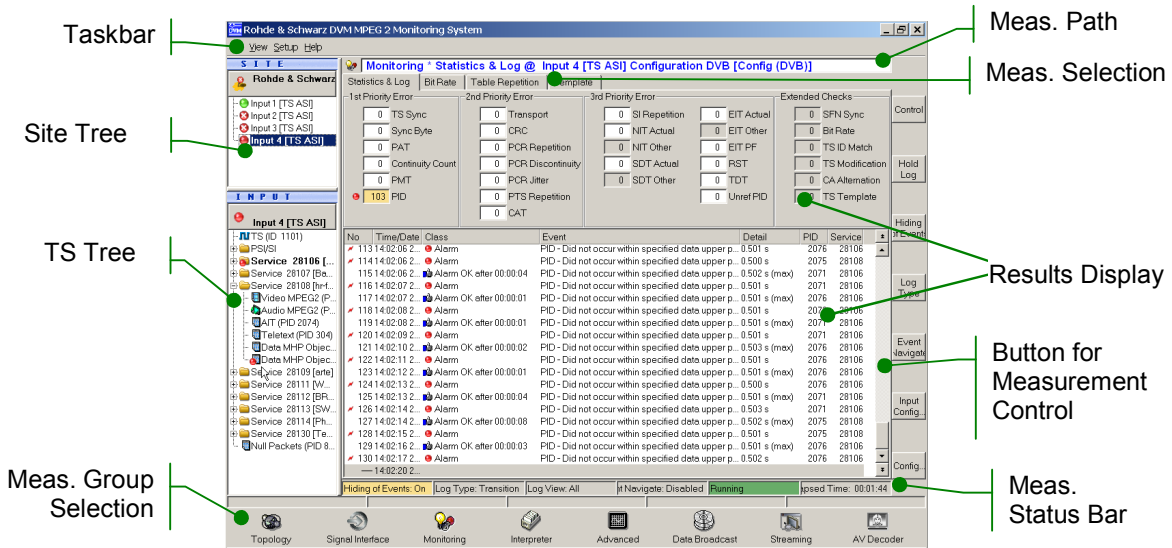

## Launching the R&amp;S DVM Analyzer Application and Creating a Basic Configuration











**Table 2.5-1: Elements on the R&S DVM measurement screen**

<b>Element</b>	<b>Description</b>
<b>Taskbar</b>	Menus for control and configuration of complete system <ul style="list-style-type: none"> <li>– File – Loading and storing of instrument settings and measured values; printout of measurement results</li> <li>– View – Selection of measurement group</li> <li>– Setup – Setting of instrument parameters</li> <li>– Help – User support</li> </ul>
<b>Site Tree</b>	List of all signal inputs with current monitoring status. An input is selected by double-clicking the name. In addition to the site name, the header contains the total status of all signal inputs.
<b>TS Tree</b>	List of elements of transport stream present at the selected input. The header contains the total status of this transport stream in addition to the input name.
<b>Measurement Group Selection</b>	Button for direct selection of a measurement group.
<b>Measurement Path</b>	Display of selected measurement with measurement path.
<b>Measurement Selection</b>	Tabs for choosing a measurement from the selected measurement group.
<b>Results Display</b>	Result display for selected measurement.
<b>Button for Measurement Control</b>	Control of selected measurement.
<b>Measurement Status Bar</b>	Display of relevant settings and states of the selected measurement.

## 2.5.4 Indication of Signal and Error States

A key feature of the R&S DVM is the indication of signal and error states of the applied transport streams. The signaled states are derived from the monitoring results. An update is therefore only performed for signal inputs for which monitoring is switched on. The table below gives an overview of signaling states.





**Table 2.5-2: Symbols used to indicate alarm and error states**

Symbol	Description	Status
	Green lamp/button	No alarm
	Red lamp/button with white cross	No transport stream found
	Red lamp/button	Alarm currently present
	Yellow lamp/button	Alarm occurred but is now gone
	Grey lamp/button	No analysis result. This lamp is always displayed together with another indication such as "monitoring stop" or "data link to analyzer interrupted".
	Red triangle	Warning currently present
	Yellow triangle	Warning occurred but is now gone
	I on blue circle	Information available (displayed only under Monitoring and in TS tree elements, not in higher-order folders of the TS tree and not in the site tree)
	Red connector	Data link to analyzer interrupted (always occurs together with a grey lamp)
	Red stop	Monitoring is stopped (always occurs together with a grey lamp)

Several elements of the site tree and the input tree can be organized in a folder. If status information is available for one or more elements, the information is displayed in the higher-order folder when the element folder is closed.

## Examples





**Table 2.5-3: Symbols for indicating alarm and error states in folders**

Symbol	Description	Status
	Closed folder	No alarm, warning or info message is present for the contained elements.
	Closed folder with red lamp + yellow triangle + red stop	The following applies to one or more signal inputs of this folder: <ul style="list-style-type: none"> <li>– An alarm signal is present</li> <li>– A warning has occurred</li> <li>– The measurement has been stopped</li> </ul>
	Closed folder with yellow lamp + red connector	The following applies to one or more signal inputs of this folder: <ul style="list-style-type: none"> <li>– An alarm occurred data link to any analyzer interrupt 1</li> <li>– The measurement has been stopped</li> </ul>
	Closed folder with grey lamp + red connector	The following applies to all signal inputs of this folder: <ul style="list-style-type: none"> <li>– No analysis result</li> <li>– Data link to analyzer interrupted</li> </ul>



## 2.5.5 The R&S DVM Measurement Groups

The following R&S DVM measurement groups can be directly selected via icons on the screen.

**Table 2.5-4: Overview of the R&S DVM measurement groups**

Symbol	Measurement Group	Property
	Topology	Combined signaling of monitoring status for all configured signal inputs on a background display. Every input is represented by a separate icon. The position of the icons can be configured. The background display can be customized and loaded.
	Signal Interface	Measurement of the physical characteristics of the input signal. The type of measurement depends on the interface used.
	Monitoring	<p>Display of monitoring status of a selected input with the following views:</p> <ul style="list-style-type: none"> <li>– Statistics &amp; Log – number and type of faults indicated as a sum and listed in chronological sequence in a report</li> <li>– Data Rate – graphical display of data rate of individual transport stream elements</li> <li>– Table Repetition – graphical display of repetition rate of SI/PSI/PSIP tables</li> <li>– Template Monitoring (TS Template Monitoring option) – display of the template used as tree with marks that indicate the deviations detected.</li> </ul> <p>Every configured input is separately monitored. The results are displayed in the form of a sum message in the site tree and under Topology.</p>
	Interpreter (Option In-depth Analysis)	<p>Display and interpretation of selectable data in the transport stream with the following options:</p> <ul style="list-style-type: none"> <li>– Packet Interpreter – display of individual transport stream packets</li> <li>– Table/PES Interpreter – display of selectable SI/PSI/PSIP tables or PES headers</li> <li>– Header Map – list of transport stream headers in chronological sequence</li> <li>– TS List – table of all transport stream elements with key specifications</li> </ul>
	Advanced (Option In-depth Analysis)	<p>In-depth measurements for timing specifications of transport stream:</p> <ul style="list-style-type: none"> <li>– PCR Jitter Analysis - analysis with recording of PCR repetition times</li> <li>– PTS Analysis – analysis of PCR/PTS shift and PTS intervals</li> </ul>

## Launching the R&amp;S DVM Analyzer Application and Creating a Basic Configuration

Symbol	Measurement Group	Property
	Data Broadcast (Option DVB Data Broadcast Analysis)	Data Broadcast Analysis: <ul style="list-style-type: none"> <li>– Overview - Displays all descriptors that refer to the selected data service in the created transport stream.</li> <li>– Interpreter - Displays the contents of an element in the protocol tree. The display depends on the service and on the type of element selected.</li> <li>– Raw Data - Displays the raw data of the element selected</li> <li>– Timing – Data and Object Carousel Timing analysis</li> </ul>
	Streaming	Start of applications for processing individual elements. <ul style="list-style-type: none"> <li>– Video Player (media player – video live picture decoding.</li> <li>– Elementary Stream Analyzer – video elementary stream analysis with the optional R&amp;S DV-ESA software.</li> <li>– DVB-H Time Slice Analyzer – unpacking and processing of DVB-H content with the Data Broadcast Analysis R&amp;S DVM-K11 option.</li> <li>– Write to file – function for storing individual TS elements on hard disk.</li> </ul>
	AV Decoder (Option Video and Audio Hardware Decoder)	Control of the integrated Video and Audio Hardware Decoder: <ul style="list-style-type: none"> <li>– TV – information about decoded video and audio signal. Display of the video signal on the integrated display (DVM400 only)</li> <li>– Decoder Status Info – status information about the hardware decoder</li> </ul>